



## ANGULAR ADVANTAGE WITH VARIOUS TIP STYLES ON A SINGLE SHANK

**Series:**  
45M, 45N, 45P, 46N, 47N, 48N,  
45Z, 16N, 17N, 18N, 18V

**Tip Style:**  
Spot, C'Sink &  
Chamfer (Front & Back)

**Lead Angles**  
18°, 30°, 40°, 45°, 50° & 60°

**Diameters**  
.31"-1.00"

**Adaptions**  
T05, T06, T08, T10, T12, T15

**Materials**  
Steel, Stainless Steel, Iron,  
Hi-Temp Alloys & Titanium



Front Chamfer



Spot Drilling



Countersinking



Slabbing

- 144°, 120°, 100°, 90°, 80° & 60° Included Angle options
- 18°, 30°, 40°, 45°, 50° & 60° Lead Angle options
- Point geometry accommodates spotting from solid
- 90° shoulder mill capability
- Low face pressure when countersinking with 2-flute positive geometry
- Recommended for large countersinks



Front/Back Chamfer



Countersinking

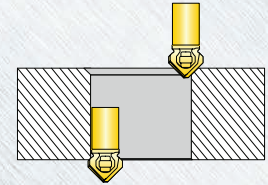

- 45° Front and 45° Back Chamfer capability
- Low face pressure when countersinking with 2- and 3-flute positive geometry
- Recommended for large countersinks



Front Chamfer



Countersinking

- 120°, 90° & 60° Included Angle options
- 30°, 45° & 60° Lead Angle options
- 4- & 6-flute promote utmost productivity for chamfers & corner breaks
- Recommended for shallow countersinks with existing hole



Front/Back Chamfer

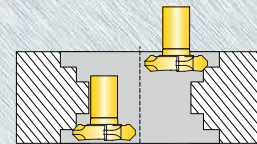

- 45° Front and 45° Back Chamfer capability
- Radial reach for back-chamfering in a bore



Countersinking



Spot Drilling

- 90° & 145° Incl. Angle
- Thin web thickness at the point prevents "tool walking"
- Accurate hole locating without use of guide bushing





## SERIES 45N, 45M, 45P

### CHAMFER AND SPOTTING TIP

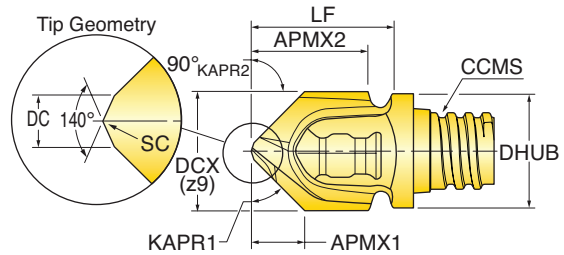

Part Number	DCX Cutting Dia. Max.	DC Cutting Diameter	KAPR1 Cutting Edge Angle	APMX1 Depth of Cut Max.	APMX2 Depth of Cut Max.	LF Functional Length	ZEFF Effective Flutes	CCMS Connection Code	DHUB Hub Diameter
<b>INCH</b>	<b>(inch)</b>	<b>(inch)</b>		<b>(inch)</b>	<b>(inch)</b>	<b>(inch)</b>			<b>(inch)</b>
45N-3704T6RA40	0.375	0.079	50	0.197	0.354	0.465	2	Chip Surfer T06	0.362
45N-3705T6RA50	0.375	0.079	40	0.140	0.378	0.530	2	Chip Surfer T06	0.362
45N-5006T8RA40	0.500	0.059	50	0.268	0.437	0.610	2	Chip Surfer T08	0.480
45N-5005T8RA50	0.500	0.059	40	0.192	0.430	0.580	2	Chip Surfer T08	0.480
45N-6207TRRA40	0.625	0.079	50	0.346	0.598	0.740	2	Chip Surfer T10	0.591
45N-6207TRRA50	0.625	0.079	40	0.244	0.587	0.748	2	Chip Surfer T10	0.594
45N-7509TSRA40	0.750	0.059	50	0.433	0.772	0.972	2	Chip Surfer T12	0.720
45N-7509TSRA50	0.750	0.059	40	0.295	0.728	0.929	2	Chip Surfer T12	0.720
<b>METRIC</b>	<b>(mm)</b>	<b>(mm)</b>		<b>(mm)</b>	<b>(mm)</b>	<b>(mm)</b>			<b>(mm)</b>
45N08007TQRA45	8.00	1.00	45	3.15	7.00	9.75	2	Chip Surfer T05	7.60
45N10009T6RA72	10.00	-	18	1.70	9.00	12.70	2	Chip Surfer T06	9.50
45P10009T6RA60	10.00	1.50	30	2.70	9.50	12.70	2	Chip Surfer T06	9.50
45N10010T6RA45	10.00	1.50	45	4.50	10.10	14.00	2	Chip Surfer T06	9.50
45M10009T6RA30	10.00	1.50	60	7.60	9.30	11.75	2	Chip Surfer T06	9.50
45P12012T8RA60	12.00	1.50	30	3.50	11.65	15.20	2	Chip Surfer T08	11.50
45N12012T8RA45	12.00	1.50	45	5.30	12.00	15.50	2	Chip Surfer T08	11.50
45M12012T8RA30	12.00	1.50	60	9.24	11.00	15.40	2	Chip Surfer T08	11.50
45P16015TRRA60	16.00	1.50	30	4.40	15.50	19.90	2	Chip Surfer T10	15.20
45N16016TRRA45	16.00	1.50	45	7.40	15.70	20.00	2	Chip Surfer T10	15.20
45M16015TRRA30	16.00	2.50	60	12.00	16.20	20.20	2	Chip Surfer T10	15.20
45P20018TSRA60	20.00	1.50	30	5.50	14.65	21.15	2	Chip Surfer T12	18.45
45N20018TSRA45	20.00	1.50	45	9.40	18.20	24.70	2	Chip Surfer T12	18.45
45M20018TSRA30	20.00	2.50	60	15.50	18.20	24.70	2	Chip Surfer T12	18.45

NOTE: When assembling, be sure tip is seated firmly on shank with no gap. DO NOT apply lubricant to the thread connection. Wrenches sold separately.

## HARDWARE - SERIES 45N, 45M, 45P

CCMS Connection Code	**OPTIONAL** Wrench	**OPTIONAL** Optional Torque Driver	Torque Value
T05	WS-0043	DT-60-04	60in/lbs
T06	WS-0029	DT-90-05	90in/lbs
T08	WS-0030	DT-130-07	130in/lbs
T10	WS-0044	DT-250-08	250in/lbs
T12	WS-0059	DT-250-09	250in/lbs



## SERIES 47N, 48N

### CHAMFER & COUNTERSINK TIP



Front Chamfer



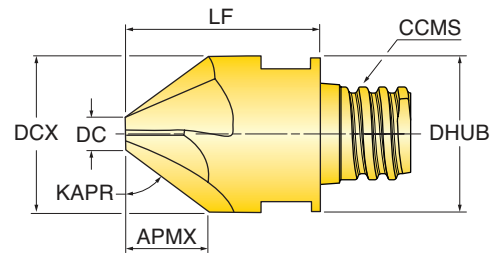

Countersinking



Part Number	DCX Cutting Dia. Max.	DC Cutting Diameter	KAPR Cutting Edge Angle	APMX Depth of Cut Max.	LF Functional Length	ZEFF Effective Flutes	CCMS Connection Code	DHUB Hub Diameter
<b>INCH</b>	<b>(inch)</b>	<b>(inch)</b>		<b>(inch)</b>	<b>(inch)</b>			<b>(inch)</b>
47N-5006T8RA30	0.500	0.079	30	0.122	0.650	4	Chip Surfer T08	0.500
47N-5006T8RA45	0.500	0.078	45	0.200	0.650	4	Chip Surfer T08	0.500
47N-5006T8RA60	0.500	0.118	60	0.256	0.650	4	Chip Surfer T08	0.500
<b>METRIC</b>	<b>(mm)</b>	<b>(mm)</b>		<b>(mm)</b>	<b>(mm)</b>			<b>(mm)</b>
47N08003TQRA45	8.00	1.95	45	3.00	10.0	4	Chip Surfer T05	8.00
47N10007T6RA60	10.00	2.00	30	2.30	13.0	4	Chip Surfer T06	10.00
48N16003TRRA30	16.00	3.00	30	3.70	20.5	6	Chip Surfer T10	16.00
48N20004TSRA30	20.00	5.00	30	4.30	25.5	6	Chip Surfer T12	18.45
48N25005TURA30	25.00	6.00	30	5.40	25.0	6	Chip Surfer T15	25.00
47N10004T6RA45	10.00	1.95	45	4.00	13.0	4	Chip Surfer T06	10.00
48N16006TRRA45	16.00	3.00	45	6.50	20.5	6	Chip Surfer T10	16.00
48N20025TSRA45	20.00	5.00	45	7.50	25.5	6	Chip Surfer T12	18.45
48N25010TURA45	25.00	5.00	45	10.00	25.0	6	Chip Surfer T15	25.00
47N10002T6RA30	10.00	1.60	60	7.30	13.0	4	Chip Surfer T06	10.00
48N16010TRRA60	16.00	4.00	60	10.00	20.5	6	Chip Surfer T10	16.00
48N20013TSRA60	20.00	5.00	60	13.00	25.5	6	Chip Surfer T12	18.45
48N25014TURA60	25.00	8.00	60	14.00	25.0	6	Chip Surfer T15	25.00

NOTE: When assembling, be sure tip is seated firmly on shank with no gap.  
DO NOT apply lubricant to the thread connection.  
Wrenches sold separately.

## HARDWARE - SERIES 47N, 48N

CCMS Connection Code	 **OPTIONAL** Wrench	 **OPTIONAL** Optional Torque Driver	Torque Value
T05	WS-0043	DT-60-06	60in/lbs
T06	WS-0029	DT-90-08	90in/lbs
T08	WS-0030	DT-130-10	130in/lbs
T10	WS-0044	DT-250-13	250in/lbs
T12	WS-0059	DT-250-16	250in/lbs
T15	WS-0061	-	350in/lbs



## SERIES 45N\_RA45

FRONT-BACK CHAMFER & COUNTERSINK TIP

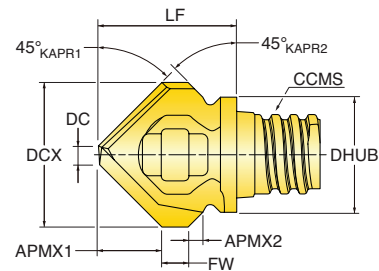

Part Number	DCX Cutting Dia. Max.	DC Cutting Diameter	APMX1 Depth of Cut Max.	APMX2 Depth of Cut Max.	FW Flat Width	LF Functional Length	ZEFF Effective Flutes	CCMS Connection Code	DHUB Hub Diameter
METRIC	(mm)	(mm)	(mm)	(mm)	(mm)	(mm)			(mm)
45N09809TQRA45	9.80	1.20	4.30	0.90	2.50	10.80	2	Chip Surfer T05	7.60
45N11814T6RA45	11.80	1.20	5.30	1.20	2.00	11.20	2	Chip Surfer T06	9.30
45N15722T8RA45	15.70	1.50	7.10	2.20	2.00	14.00	2	Chip Surfer T08	11.50

NOTE: When assembling, be sure tip is seated firmly on shank with no gap. DO NOT apply lubricant to the thread connection. Wrenches sold separately.

## SERIES 46N\_RA45

FRONT-BACK CHAMFER & COUNTERSINK TIP

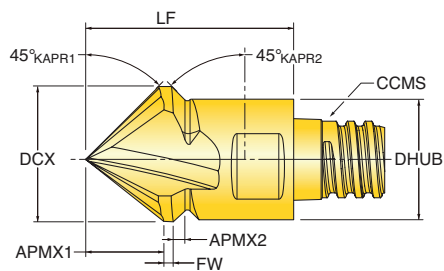

Part Number	DCX Cutting Dia. Max.	APMX1 Depth of Cut Max.	APMX2 Depth of Cut Max.	FW Flat Width	LF Functional Length	ZEFF Effective Flutes	CCMS Connection Code	DHUB Hub Diameter
METRIC	(mm)	(mm)	(mm)	(mm)	(mm)			(mm)
46N11610T6RA45	11.60	5.80	1.00	1.00	16.50	3	Chip Surfer T06	9.55

NOTE: When assembling, be sure tip is seated firmly on shank with no gap. DO NOT apply lubricant to the thread connection. Wrenches sold separately.

## HARDWARE - SERIES 45N\_RA45, 46N\_RA45

CCMS Connection Code	**OPTIONAL** Wrench	**OPTIONAL** Optional Torque Driver	Torque Value
T05	WS-0029	-	60in/lbs
T06	WS-0030	DT-90-07	90in/lbs
T08	WS-0044	DT-130-08	130in/lbs



## SERIES 45Z (CENTER DRILL)

SOLID CARBIDE CENTER DRILL TIP

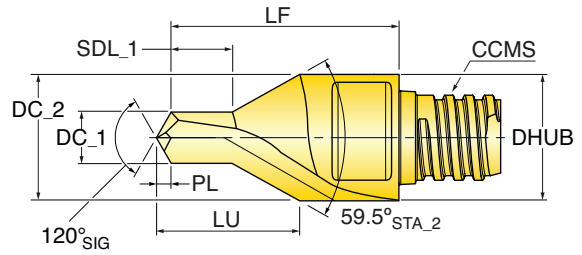

Part Number	DC Size Desig. (ANSI B94)	DC1 Cutting Dia. 1st Step	DC2 Cutting Dia. 2nd Step	PL Point Length	SDL_1 Step Dia. Length 1st Step	LU Usable Length	LF Functional Length	ZEFF Effective Flutes	FHA Flute Helix Angle	CCMS Connection Code	DHUB Hub Diameter
<b>INCH</b>											
45Z-1221TQRA06	#4	0.130	0.310	0.037	0.163	0.310	0.552	2	12	Chip Surfer T05	0.310
45Z-1851T8RA09	#5	0.190	0.500	0.054	0.245	0.571	0.855	2	12	Chip Surfer T08	0.500
45Z-2152T8RA09	#6	0.218	0.500	0.063	0.236	0.545	0.846	2	12	Chip Surfer T08	0.500
45Z-2564TRRA11	#7	0.252	0.625	0.072	0.250	0.649	1.030	2	12	Chip Surfer T10	0.625
<b>METRIC</b>											
45Z03208TQRA15		3.28 mm	8.00 mm		4.60 mm		15.00 mm	2	12	Chip Surfer T05	
45Z04111T6RA19		4.12 mm	10.00 mm		5.90 mm		19.00 mm	2	12	Chip Surfer T06	
45Z05113T8RA23		5.13 mm	12.00 mm		7.20 mm		23.00 mm	2	12	Chip Surfer T08	
45Z06517TRRA28		6.46 mm	12.00 mm		8.90 mm		28.00 mm	2	12	Chip Surfer T10	

NOTE: When assembling, be sure tip is seated firmly on shank with no gap.  
DO NOT apply lubricant to the thread connection.  
Wrenches sold separately.

## HARDWARE - SERIES 45Z

CCMS Connection Code	**OPTIONAL** Wrench	**OPTIONAL** Optional Torque Driver	Torque Value
T05	WS-0043	DT-60-06	60in/lbs
T06	WS-0029	DT-90-08	90in/lbs
T08	WS-0030	DT-130-10	130in/lbs
T10	WS-0044	DT-250-13	250in/lbs



## SERIES 45Z\_RA (NC SPOT DRILL)

COUNTERSINK TIP: 145° AND 90° INCLUDED ANGLES

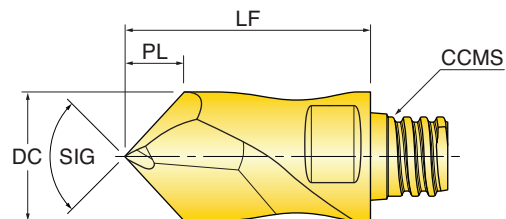

Part Number	DC Cutting Diameter	SIG Point Angle	PL Point Length	LF Functional Length	ZEFF Effective Flutes	CCMS Connection Code	DHUB Hub Diameter
<b>INCH</b>	<b>(inch)</b>		<b>(inch)</b>	<b>(inch)</b>			<b>(inch)</b>
45Z-3101TQRA72	0.312	145	0.043	0.393	2	Chip Surfer T05	0.312
45Z-3701T6RA72	0.375	145	0.050	0.511	2	Chip Surfer T06	0.375
45Z-5001T6RA72	0.500	145	0.069	0.650	2	Chip Surfer T08	0.500
45Z-6201TRRA72	0.625	145	0.084	0.807	2	Chip Surfer T10	0.625
<b>METRIC</b>	<b>(mm)</b>		<b>(mm)</b>	<b>(mm)</b>			<b>(mm)</b>
45Z08001TQRA72	8.00 mm	145	1.10 mm	10.00 mm	2	Chip Surfer T05	8.00 mm
45Z08004TQRA45	8.00 mm	90	3.67 mm	15.00 mm	2	Chip Surfer T05	8.00 mm
45Z10001T6RA72	10.00 mm	145	1.34 mm	13.00 mm	2	Chip Surfer T06	10.00 mm
45Z10005TQRA45	10.00 mm	90	4.56 mm	19.00 mm	2	Chip Surfer T06	10.00 mm
45Z12001T8RA72	12.00 mm	145	1.64 mm	16.50 mm	2	Chip Surfer T08	12.00 mm
45Z12006T6RA45	12.00 mm	90	5.46 mm	23.00 mm	2	Chip Surfer T08	12.00 mm
45Z16001TRRA72	16.00 mm	145	2.36 mm	20.50 mm	2	Chip Surfer T10	16.00 mm
45Z16008TRRA45	16.00 mm	90	7.33 mm	28.00 mm	2	Chip Surfer T10	16.00 mm

NOTE: When assembling, be sure tip is seated firmly on shank with no gap.  
DO NOT apply lubricant to the thread connection.  
Wrenches sold seperately.

## HARDWARE - SERIES 45Z\_RA

CCMS Connection Code	**OPTIONAL** Wrench	**OPTIONAL** Optional Torque Driver	Torque Value
T05	WS-0043	DT-60-06	60in/lbs
T06	WS-0029	DT-90-08	90in/lbs
T08	WS-0030	DT-130-10	130in/lbs
T10	WS-0044	DT-250-13	250in/lbs



## SERIES 16N\_K

FRONT & BACK CHAMFER TIP

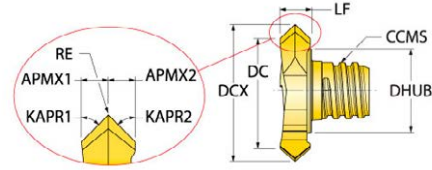

Part Number	DCX Cutting Dia. Max.	DC Cutting Diameter	KAPR1 Cutting Edge Angle	APMX1 Depth of Cut Max.	KAPR2 Cutting Edge Angle	APMX2 Depth of Cut Max.	RE Corner Radius	LF Functional Length	ZEFF Effective Flutes	CCMS Connection Code	DHUB Hub Diameter
16N17734T6RK14	0.697	0.562	45	0.067	45	0.067	0.004	0.142	3	Chip Surfer T06	0.36

## SERIES 16N\_P

FRONT/BACK CHAMFER TIP, KEEN EDGE

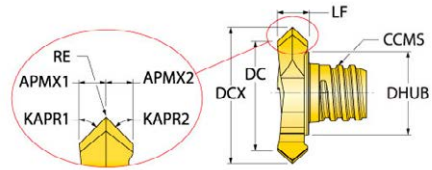

Part Number	DCX Cutting Dia. Max.	DC Cutting Diameter	KAPR1 Cutting Edge Angle	APMX1 Depth of Cut Max.	KAPR2 Cutting Edge Angle	APMX2 Depth of Cut Max.	RE Corner Radius	LF Functional Length	ZEFF Effective Flutes	CCMS Connection Code	DHUB Hub Diameter
16N17734T6RP14	0.697	0.586	45	0.055	45	0.055	0.004	0.142	3	Chip Surfer T06	0.36

NOTE: When assembling, be sure tip is seated firmly on shank with no gap.  
DO NOT apply lubricant to the thread connection.  
Wrenches sold separately.

## HARDWARE - SERIES 16N\_K, 16N\_P

CCMS Connection Code	Torque Value	**OPTIONAL** L-Key	**OPTIONAL** Adjustable Torque Wrench Handle	**OPTIONAL** Torx Bit Socket	**OPTIONAL** 90° Socket Adapter
T06	90in/lbs	DS-T25L	DS-T2538SKT	DS-38SKT9X12	WRENCHTORQUE5-50Nm9X12



## SERIES 17N

EXTENDED NECK FRONT & BACK CHAMFER TIP

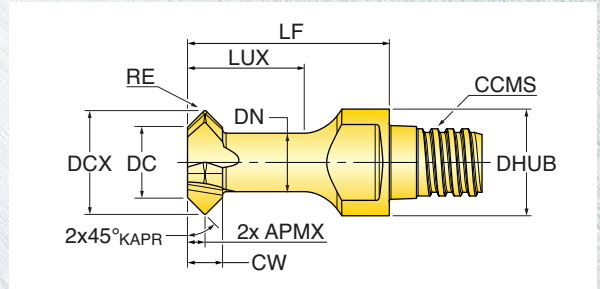

Part Number	DCX Cutting Dia. Max.	DC Cutting Diameter	KAPR1 Cutting Edge Angle	APMX1 Depth of Cut Max.	KAPR2 Cutting Edge Angle	APMX2 Depth of Cut Max.	RE Corner Radius	LF Functional Length	ZEFF Effective Flutes	CCMS Connection Code	DHUB Hub Diameter
17N0772TQRK12	7.70 mm	5.30 mm	45	1.20 mm	45	1.20 mm	0.20 mm	15.20 mm	4	Chip Surfer T05	8.00 mm

NOTE: When assembling, be sure tip is seated firmly on shank with no gap.  
DO NOT apply lubricant to the thread connection.  
Wrenches sold seperately.

## HARDWARE - SERIES 17N

CCMS Connection Code	**OPTIONAL** Wrench	**OPTIONAL** Adjustable Torque Wrench Handle	Torque Value
T05	WS-0043	DT-60-06	60 in/lbs



## SERIES 17N\_K

FRONT & BACK CHAMFER TIP

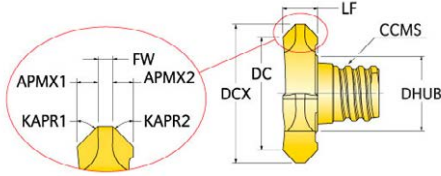

Part Number	DCX Cutting Dia. Max.	DC Cutting Diameter	KAPR1 Cutting Edge Angle	APMX1 Depth of Cut Max.	KAPR2 Cutting Edge Angle	APMX2 Depth of Cut Max.	FW Flat Width	LF Functional Length	ZEFF Effective Flutes	CCMS Connection Code	DHUB Hub Diameter
17N21755T8RK17	0.854	0.720	45.0	0.067	45.0	0.067	0.060	0.224	4	Chip Surfer T08	0.480

## SERIES 17N\_P

FRONT/BACK CHAMFER TIP, KEEN EDGE

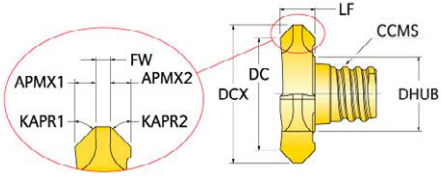

Part Number	DCX Cutting Dia. Max.	DC Cutting Diameter	KAPR1 Cutting Edge Angle	APMX1 Depth of Cut Max.	KAPR2 Cutting Edge Angle	APMX2 Depth of Cut Max.	FW Flat Width	LF Functional Length	ZEFF Effective Flutes	CCMS Connection Code	DHUB Hub Diameter
17N21755T8RP17	0.854	0.720	45.0	0.067	45.0	0.067	0.060	0.224	4	Chip Surfer T08	0.480

NOTE: When assembling, be sure tip is seated firmly on shank with no gap.  
DO NOT apply lubricant to the thread connection.  
Wrenches sold separately.

## HARDWARE - SERIES 17N\_K, 17N\_P

CCMS Connection Code	Torque Value	**OPTIONAL** L-Key	**OPTIONAL** Adjustable Torque Wrench Handle	**OPTIONAL** Torx Bit Socket	**OPTIONAL** 90° Socket Adapter
T08	130in/lbs	DS-T30/3L	DS-T3038SKT	DS-38SKT9X12	WRENCHTORQUE5-50Nm9X12



## SERIES 18N

### FRONT & BACK CHAMFER TIP



Front/Back Chamfer

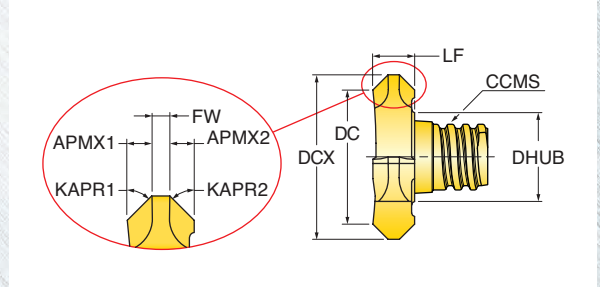

Part Number	DCX Cutting Dia. Max.	DC Cutting Diameter	KAPR1 Cutting Edge Angle	APMX1 Depth of Cut Max.	APMX2 Depth of Cut Max.	KAPR2 Cutting Edge Angle	FW Flat Width	LF Functional Length	ZE Effective Flutes	CCMS Connection Code	DHUB Hub Diameter
18N-6216T6RN06	0.625	0.533	45.0	0.046	0.046	45.0	0.030	0.159	6	Chip Surfer T06	0.364
18N27798TRRK40	1.090	0.775	45.0	0.156	0.156	45.0	0.020	0.418	6	Chip Surfer T10	0.600

NOTE: When assembling, be sure tip is seated firmly on shank with no gap.  
DO NOT apply lubricant to the thread connection.  
Wrenches sold separately.

## HARDWARE - SERIES 18N

CCMS Connection Code	Torque Value	**OPTIONAL** L-Key	**OPTIONAL** Adjustable Torque Wrench Handle	**OPTIONAL** Torx Bit Socket	**OPTIONAL** 90° Socket Adapter
T06	90 in/lbs	DS-T25L	DS-T3038SKT	DS-T2538SKT	WRENCHTORQUE5-50Nm9X12
T10	250 in/lbs	DS-T40/3L	DS-T3038SKT	DS-T4038SKT	WRENCHTORQUE5-50Nm9X12



## SERIES 18V

DOVETAIL TIP

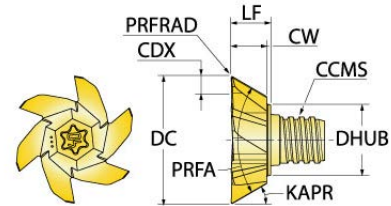

Part Number	DC Cutting Diameter	PRFA Profile Angle	KAPR Cutting Edge Angle	PRFRAD Profile Radius	CW Cutting Width	CDX Cutting Depth Max.	LF Functional Length	ZEFF Effective Flutes	CCMS Connection Code	DHUB Hub Diameter
18V-5006TQRA30	0.50	120.0	60.0	0.008	0.056	0.08	0.09	6	Chip Surfer T05	0.300
18V-5010TQRA45	0.50	90.0	45.0	0.008	0.086	0.08	0.13	6	Chip Surfer T05	0.300
18V-5016TQRA60	0.50	60.0	30.0	0.008	0.140	0.08	0.18	6	Chip Surfer T05	0.300
18V-5016TQRA63	0.50	55.0	27.5	0.008	0.154	0.08	0.18	6	Chip Surfer T05	0.300
18V-5016TQRA70	0.50	40.0	20.0	0.008	0.161	0.06	0.18	6	Chip Surfer T05	0.300
18V-5027T6RA75	0.50	30.0	15.0	0.008	0.270	0.07	0.65	6	Chip Surfer T06	0.360
18V-5040T6RA80	0.50	20.0	10.0	0.008	0.400	0.07	0.65	6	Chip Surfer T06	0.360
18V-5044T6RA85	0.50	10.0	5.0	0.008	0.430	0.04	0.65	6	Chip Surfer T06	0.360
18V27710TRRP75	1.09	30.0	15.0	0.008	0.398	0.09	0.46	6	Chip Surfer T10	0.600
18V27750TRRP45	1.09	90.0	45.0	0.008	0.197	0.16	0.23	6	Chip Surfer T10	0.600
18V27778TRRP60	1.09	60.0	30.0	0.008	0.307	0.16	0.34	6	Chip Surfer T10	0.600

NOTE: When assembling, be sure tip is seated firmly on shank with no gap.  
DO NOT apply lubricant to the thread connection.  
Wrenches sold separately.

## HARDWARE - SERIES 18V

CCMS Connection Code	<b>**OPTIONAL**</b> Wrench	<b>**OPTIONAL**</b> Adjustable Torque Wrench Handle	Torque Value	<b>**OPTIONAL**</b> L-Key	<b>**OPTIONAL**</b> Adjustable Torque Wrench Handle	<b>**OPTIONAL**</b> Torx Bit Socket	<b>**OPTIONAL**</b> 90° Socket Adapter
T05	-	-	60 in/lbs	DS-T20/3L	DS-T2038SKT	DS-38SKT9X12	WRENCHTORQUE5-50Nm9X12
T06	WS-0029	DT-90-08	90 in/lbs	-	-	-	-
T10	-	-	250 in/lbs	DS-T40/3L	DS-T4038SKT	DS-38SKT9X12	WRENCHTORQUE5-50Nm9X12



## OPERATING GUIDELINES - MILLING 45M, 45N, 45P, 46N, 47N, 48N



### RPM Calculation

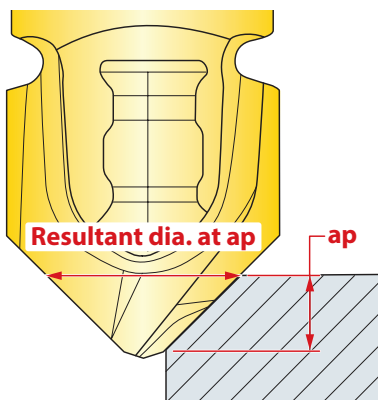

Calculation is to be made using the resultant diameter at ap.

### Chip Thinning

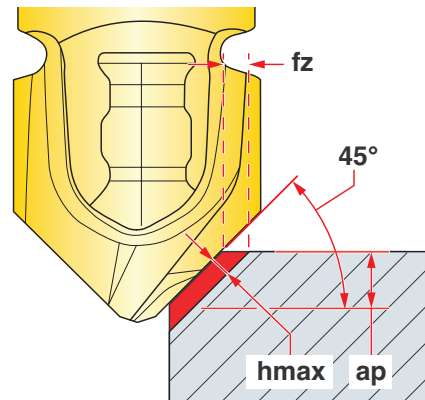

Chip Thinning Calculator is recommended to ensure hmax falls within fz range.

Material	Brinnell Hardness	SFM	fz Feed per Tooth	Coolant	
Steel	Low Carbon 1018, 8620	150-250	350-600	No	
	High Carbon F-6180	250-400			
	Alloyed Steel 4140, 4340	150-300			
	Tool Steel A-6, D-1, D-2	Up to 300			
Stainless Steel	300 Series, 304, 316	-	250-500	May not be needed at high speeds	
	400 Series 15-5 PH	Up to 320		.002-.004	
	13-8 PH	-		Yes	
Cast Iron	Gray	150-250	450-700	.002-.005	No
	Nodular	150-250	400-600	.002-.004	
Aluminum	6061 T-6, 7075 T-6, 2024	-	1300-4000	.003-.006	Yes
Nickel Alloys	Inconel, Hastelloy, Waspalloy	-	75-125	.002-.004	Yes
Titanium	6AL-4V	-	125-200	.002-.004	Yes

## OPERATING GUIDELINES - SPOT/C'SINK 45M, 45N, 45P, 46N, 47N, 48N



Material	Brinnell Hardness	SFM	f Feed per Revolution	Coolant	
Steel	Low Carbon 1018, 8620	150-250	200-500	No	
	High Carbon F-6180	250-400			
	Alloyed Steel 4140, 4340	150-300			
Stainless Steel	300 Series, 304, 316	-	200-400	May not be needed at high speeds	
	400 Series 15-5 PH	Up to 320		.003-.006	
	13-8 PH	-		Yes	
Cast Iron	Gray	150-250	250-550	No	
	Nodular	150-250			
Titanium	6AL-4V	-	70-150	.002-.005	Yes

Note: Feed and speed recommendations are starting operating parameters. They are only guidelines from which further optimization should take place. Operating parameters are influenced by many machining variables. These variables may cause for reductions in feeds and speed or dramatic increases. Additionally, DOC and WOC may need to be revised to optimize the tools performance.



## OPERATING GUIDELINES - 45Z

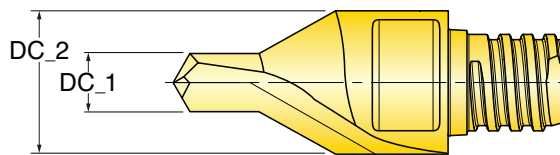

Calculate speed and feed based on DC\_1.

\*Feed / Rev is based on Two-Effective (do not double).

Materials				Vc Cutting Speed SFM	DC Cutting Diameter (inch)	f* Feed/Rev (inch)
ISO	Mat'l Group #VDI 3323	Type	Examples			
<b>P</b>	1 - 5	Non-alloy Steel	1018, A36, 1045, A572, 1070	170-450	0.118-0.185	.002-.006
					0.186-0.292	.003-.007
	6 - 9	Low-alloy Steel	4140, 4340, P20, 8620, 300M		0.118-0.185	.002-.004
					0.186-0.292	.002-.005
	10 - 11	High-alloy Steel	H13, A2, D2, M2, T1		0.118-0.185	.002-.004
					0.186-0.292	.002-.005
<b>M</b>	12 - 14	Stainless Steel	410, 416, 440, 303, 304, 316, 15-5, 17-4	100-230	0.118-0.185	.002-.004
				0.186-0.292	.002-.005	
<b>K</b>	15 - 18	Iron	CLS. 20, 30, 45, 60-40-18, 100-70-03	265-550	0.118-0.185	.005-.010
				0.186-0.292	.007-.013	
<b>N</b>	21 - 30	Non Ferrous & Non Metallic	7075, 6061, Duroplastics	300-725	0.118-0.185	.003-.010
				0.186-0.292	.007-.014	
<b>S</b>	31 - 37	High-Temp, Ti	Inconel, Hastelloy, 6Al-4V	70-165	0.118-0.185	.001-.003
				0.186-0.292	.002-.004	
<b>H</b>	38-39	Hardened Steel >48	A2, O1, D2	50-125	0.118-0.185	.001-.002
				0.186-0.292	.001-.003	

Note: Feed and speed recommendations are starting operating parameters. They are only guidelines from which further optimization should take place. Operating parameters are influenced by many machining variables. These variables may cause for reductions in feeds and speed or dramatic increases. Additionally, DOC and WOC may need to be revised to optimize the tools performance.



## OPERATING GUIDELINES - 45Z\_RA



### RPM Calculation

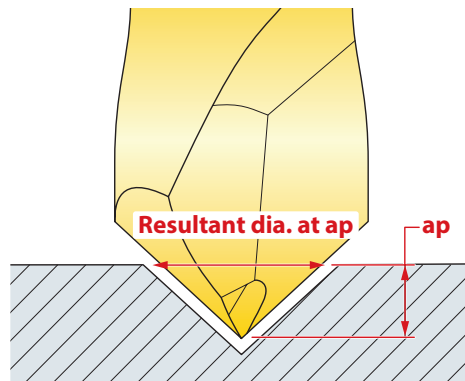

Calculation is to be made using the resultant diameter at ap.

\*Feed / Rev is based on Two-Effective (do not double).

ISO	Material	Brinnell Hardness	Vc Cutting Speed SFM	f* Feed/Rev (inch)	Coolant	
<b>P</b>	Steel	Low Carbon 1018, 8620	150-250	200-500	.003-.008	No
		High Carbon F-6180	250-400			
		Alloyed Steel 4140, 4340	150-300			
<b>M</b>	Stainless Steel	300 Series, 304, 316	-	200-400	.003-.006	May not be needed at high speeds
		400 Series 15-5 PH	Up to 320			
		13-8 PH	-			Yes
<b>K</b>	Cast Iron	Gray	150-250	250-550	.003-.010	No
		Nodular	150-250			
<b>S</b>	Titanium	6AL-4V	-	70-150	.002-.005	Yes

Note: Feed and speed recommendations are starting operating parameters. They are only guidelines from which further optimization should take place. Operating parameters are influenced by many machining variables. These variables may cause for reductions in feeds and speed or dramatic increases. Additionally, DOC and WOC may need to be revised to optimize the tools performance.



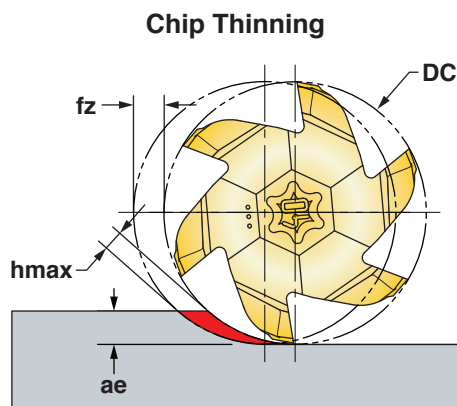

\* Chip Thinning Calculator is recommended to ensure  $h_{max}$  is within  $f_z$  range.

ISO	Materials			Vc Cutting Speed SFM	fz* Feed/Tooth (inch)	Coolant
	Mat'l Group #VDI 3323	Type	Examples			
<b>P</b>	1 thru 5	Non-alloy Steel	1018, A36, 1045, A572, 1070	450-800	.002-.006	No
	6 thru 9	Low-alloy Steel	4140, 4340, P20, 8620, 300M	400-750	.002-.005	
	10, 11	High-alloy Steel	H13, A2, D2, M2, T1	400-700	.002-.005	
<b>M</b>	12 thru 14	Stainless Steel	410, 416, 440, 303, 304, 316, 15-5, 17-4	200-500	.002-.005	May not be required at high speeds
<b>K</b>	15 thru 18	Iron	CLS. 20, 30, 45, 60-40-18, 100-70-03	500-800	.002-.006	No
<b>S</b>	31 thru 37	High-Temp, Ti	Inconel, Hastelloy, 6Al-4V, 5Al-5Mo-5V-3Cr	65-250	.002-.005	Yes

Note: Feed and speed recommendations are starting operating parameters. They are only guidelines from which further optimization should take place. Operating parameters are influenced by many machining variables. These variables may cause for reductions in feeds and speed or dramatic increases. Additionally, DOC and WOC may need to be revised to optimize the tools performance.



## INDEXING CHIP SURFER TIPS

- Step 1: Screw tip into shank until finger tight (Figure 1a). Note a .010" gap (Figure 1b).
- Step 2: Use wrench to torque approximately 1/4 turn, creating a simultaneous fit (Figure 2).
- Step 3: Use .001" shim stock to check the simultaneous fit at the intersection of the tip and the shank. The shim should not be able to enter the intersection (Figure 3a). If it does, tighten further with the wrench until there is no gap (Figure 3b).

Note: Pre-set torque wrenches (series DT- . . .) can be purchased.

Figure 1a. Finger tight



Figure 1b. .010" gap



Figure 2. 1/4 turn



Figure 3a. Shim should NOT enter intersection



Figure 3b. Proper fit



Series DT- . . . Optional Torque Wrench

