

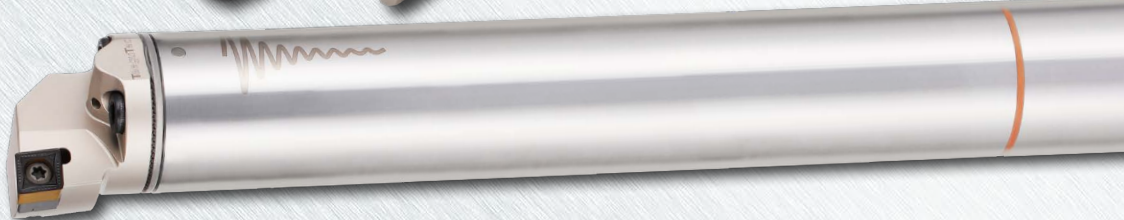

# T ABSORBER™

TURNING PRODUCTS



**Lengths:**  
7xD  
10xD

**Diameters:**  
Inch (stocked):  
.625", .750", 1.00", 1.25",  
1.50", 2.00", 2.50"

Metric (stocked overseas)  
16mm, 20mm, 25mm, 32mm,  
40mm, 50mm, 60mm

**Head / Insert Styles:**

**Positive:**  
- CCMT 21.5/32.5/43  
- DCMT 21.5/32.5  
- VBMT 22/33

**Negative:**  
- CNMX 2.22  
- CNMX 43.5  
- DNMG 3.53.5  
- DNMX 2.22  
- VNMX 2.53  
- WNMX 2.22

**ID Threading:**  
161R / 221R

## 7xD and 10xD Anti-Vibration Boring Bars With Exchangeable Heads

Machining depths applied in internal turning (boring) applications differ according to the materials from which the boring bars are made; steel bars are used up to 3xD (bar diameter) and carbide boring bars up to 5xD. Deep boring, however, is very difficult to machine even with carbide bars. With the introduction of Ingersoll's T-Absorber boring bars and heads, it's now possible to bore and thread deep holes up to 10xD.

T-Absorber features an internal damping system that enables this deep boring capability. A serrated, rigid connection allows a variety of heads to be mounted to each bar, and in combination with the damping mechanism provides more stable machining that results in very good surface finish and longer tool life. The ability to absorb radial and axial tool force fluctuations means that increased feed rates and cutting speeds can be applied, thereby increasing productivity.

**Features and Benefits:**

- Internal boring and threading with L/D ratios of 7xD and 10xD
- Significantly reduce and in some cases completely eliminate vibration
- Unique damping mechanism located inside the body of the bar
- Serrated coupling design for robust tightening
- Internal coolant supply improves chip control & evacuation
- Multiple head designs for different shape positive & negative inserts



**TABSORBER™**

In order to cover the complete range of applications for internal turning, Ingersoll provides a comprehensive series of high-quality internal boring bars for different insert geometries, covering all machining applications from 4xD to 10xD. Three types of boring bars are available: solid steel, solid carbide and anti-vibration.

Generally speaking, the recommended overhang for solid steel boring bars should not exceed 3xD. Under very stable conditions the maximum overhang can approach 4xD. This limitation is due the elasticity and characteristics of the steel material which can induce unwelcome vibrations.

In order to limit the vibration on overhangs between 4xD and 6xD, the use of solid carbide boring bars is recommended, as they represent an excellent, highly efficient option for boring applications of up to six times the tool's machining depth. This capability is attributed to solid carbide possessing a coefficient of elasticity that is three times higher than that of steel. However, when machining with overhangs beyond 6xD even the use of a solid carbide boring bar can cause deflection and vibrations.

**Boring bar machining range (based on maximum depth of cut)**

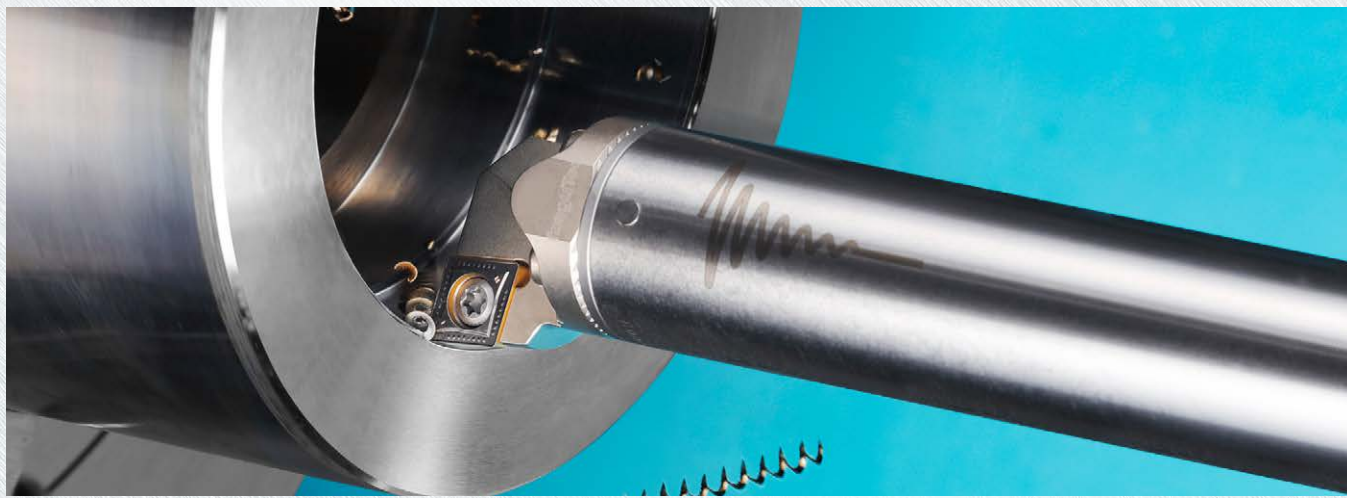
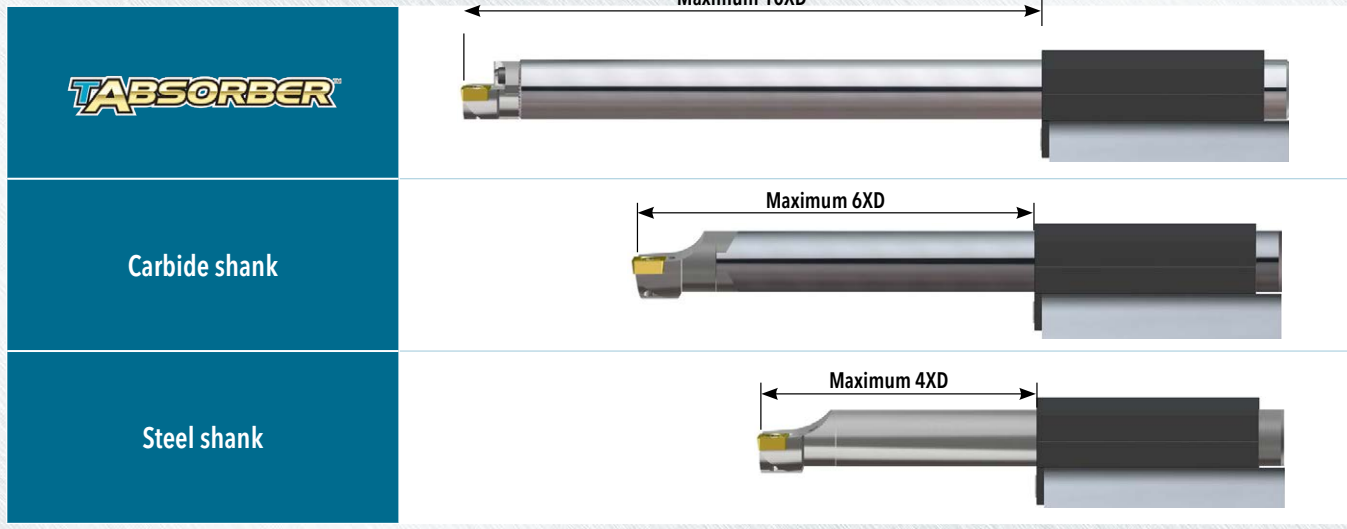

**TABSORBER™ FEATURES**

**Shank:**

- Internal vibration damping system
  - Good surface finish and tool life
  - Larger depth of cut and feed provides higher productivity
- Serrated coupling design for robust tightening
- Corrosion resistant stainless steel shanks
- Available as standard items in 2 different lengths: 7XD, 10XD
- Shanks available as standard items in 7 diameters: .625, .750, 1.00, 1.25, 1.50, 2.00 and 2.50
- 7 Metric shanks also available: 16mm, 20mm, 25mm, 32mm, 40mm, 50mm and 60mm



**Exchangeable Head:**

- A variety of head types with various specifications
- Available inserts
  - ISO positive inserts: CCMT, DCMT, VBMT
  - Rhino-Turn negative inserts: DNMG 3.5, VNMX 2.5
  - Rhino-TurnM negative inserts: CNMX 2.2, DNMX 2.2, WNMX 2.2
  - GoldDuty negative inserts: CNMX43.5
  - Lay down threading inserts: 16IR, 22IR
- Coolant-thru system direct to the cutting edge for improved chip control and longer tool life

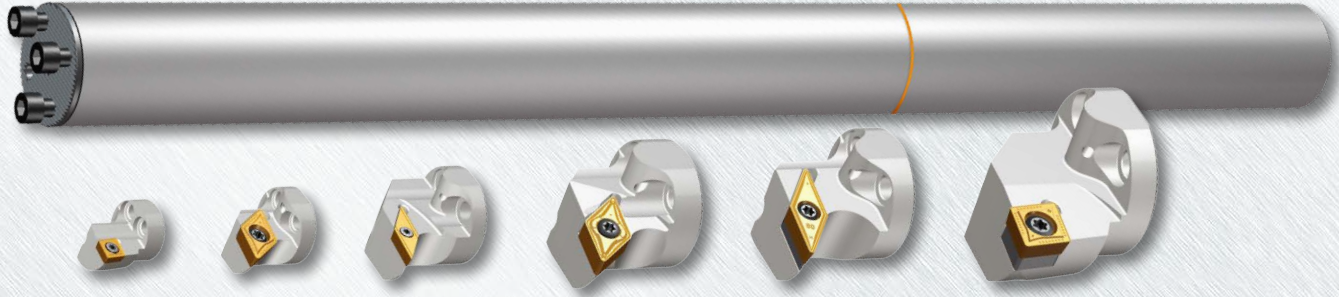
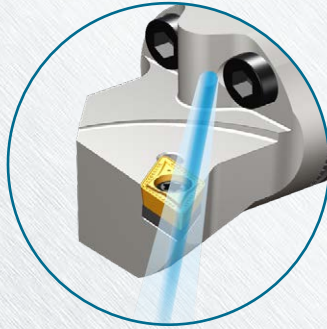

**Standard Shank Designation System**

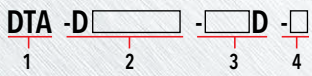

- 1) T-Absorber shank
- 2) Shank diameters: .625, .750, 1.00, 1.25, 1.50, 2.00 and 2.50
- 3) Shank length 7XD, 10XD
- 4) Shank material and coolant hole
  - E: Internal supply type steel shank
  - C: Internal supply type carbide shank

Example: DTA-D1.00-10D-C

**Standard Head Designation System**

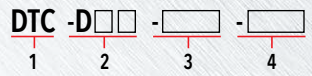

- 1) T-Absorber head
- 2) Shank-to-head connection size  
Ø16, 20, 25, 32, 40 mm
- 3) Head type (same as standard boring bars)
- 4) Insert size (ISO)

Example: DTC-D20-SCLCR-09

## TABSORBER™ FEATURES

Deep turning solutions for machining high depth to diameter internal applications include special anti-vibration boring bar systems with a 'live' vibration dampening system located inside the tool body.



Ingersoll's innovative T-ABSORBER anti-vibration boring bars have been designed to significantly reduce and even totally eliminate vibrations when working with a high overhang from 7xD to 10xD. Situated inside these tools is a unique damping mechanism that consists of a heavy mass that is supported by a rubber spring element containing oil to increase the required dampening effect.

In addition, the system contains other elements which help to further reduce vibrations. The reactive damping mechanism comes into action during machining with high overhang work depths and acts as an effective counter to vibrations. The highly effective, anti-vibration damper effect is applicable for large D.O.C and high feed rates, and ensures continuous, efficient machining. The new anti-vibration tools dramatically improve machining stability and prolong insert life. These factors enable meaningful increases in productivity to be achieved, improvements in surface quality on high overhangs to be attained, scrap levels to be reduced and users' profitability to be enhanced.

T-ABSORBER anti-vibration tools enable the delivery of internal coolant to be supplied directly to where it is required - the insert's cutting edge. The efficient distribution of coolant increases the insert's tool life by reducing temperature and also improves chip control and chip evacuation



## TABSORBER™ INSERT SELECTION

Select inserts that generate low cutting forces:

- **Insert Style:** In general, positive (single-side) screw-held inserts generate lower tool pressure than negative (double-side) inserts, and the more positive the rake face angle the lower the tool pressure

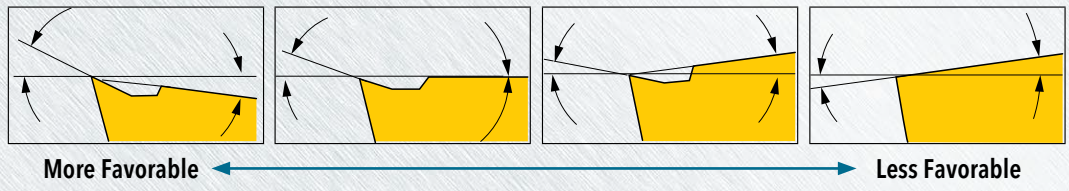

- **Insert Shape:** D-type provides more advantages than C-type due to larger clearance and reduced contact area of the cutting edge



- **Lead Angle:** Stay as close to a 90-degree entering angle as possible.

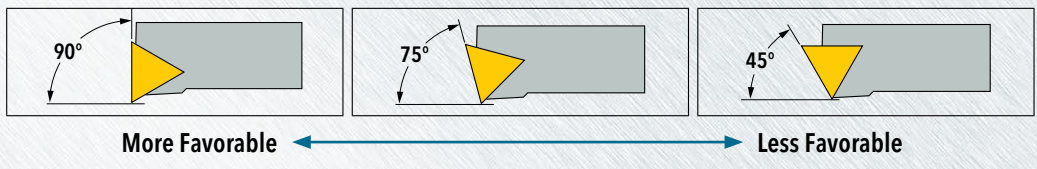

- **Corner Radii:** Inserts with smaller corner radii will reduce tool pressure. It's ideal for the depth of cut to exceed the corner radius

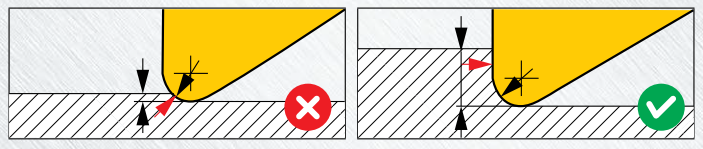

- **Chip Breakers:** Long chips can cause vibrations, so it is recommended to use an insert capable of breaking chips at the desired feed rate and depth-of-cut

- **Wiper Geometry:** Not recommended due to more radial engagement that can cause more tool pressure and vibration

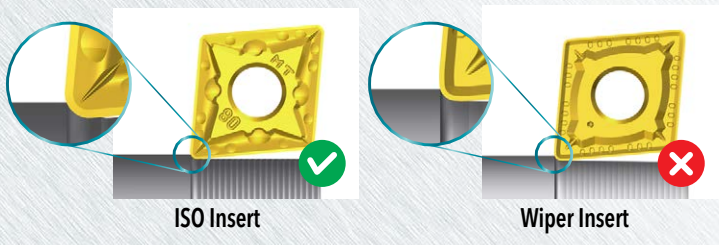

**TABSORBER™ BORING BAR SELECTION**

• **Shank Length:** The internal damping mechanism is located toward the head of the bar. If necessary, it is possible to modify (cut-off) the bar up to the red line marked on each shank



Bar Diameter	INCH	
	Minimum Length After Shortening	
DCONMS	7xD	10xD
0.625	4.6	Not Recommended
0.750	5.6	Not Recommended
1.000	6.7	10.3
1.250	9.0	12.5
1.500	11.4	15.1
2.000	12.4	21.0
2.500	16.8	26.8

Bar Diameter	METRIC	
	Minimum Length After Shortening	
DCONMS	7xD	10xD
16	100	Not Recommended
20	125	Not Recommended
25	155	255
32	190	320
40	240	410
50	305	520
60	380	630

- **Bar Diameter:** It's important that the minimum bore diameter (Dmin) be 10-20% smaller than the machined bore in order to provide adequate chip evacuation, particularly in gummy materials where it is difficult to break a chip
- **Bar positioning:** Work with the bar upside-down. This creates forces in the opposite direction to the bars weight, thus reducing the moment exerted on the tool post

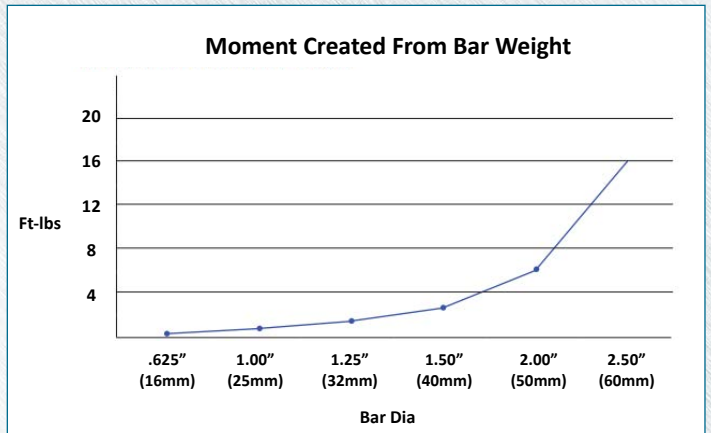

**TABSORBER™ SETTING INSTRUCTIONS**



Set the shank to the holder so that the head's upper surface is horizontal to the gauge.



It's strongly recommended that the length of the mounted shank be at least 4xD.

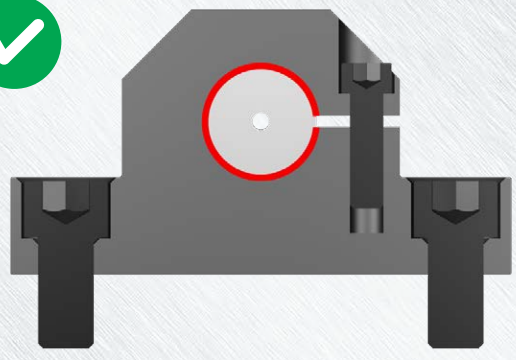

Ingersoll recommends the use of slit holders that have full cylindrical contact with the shank.

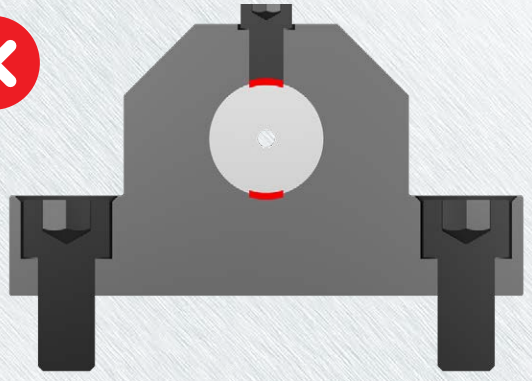

It is not recommended to use side lock clamping during operation; this will push the screw directly against the shank.

**TABSORBER™ SERIES DTA (INCH)**

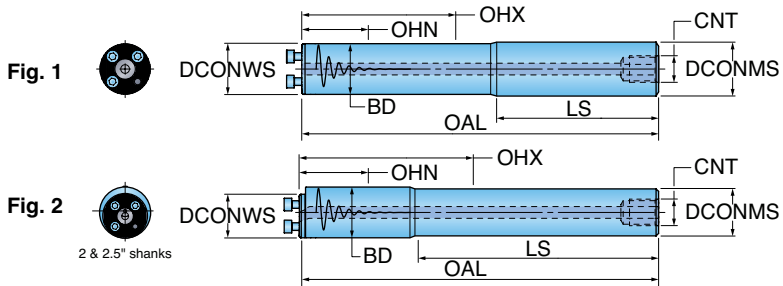

Part Number	Dimension (inch)							CNT Coolant Entry Thread Size	BMC <sup>(3)</sup> Body Material Code	Figure
	DCONMS Connection Dia. Machine Side	DCONWS <sup>(1)</sup> Connection Dia. Workpiece Side	BD Body Dia.	OAL <sup>(2)</sup> Overall Length	LS Shank Length	OHN Min. Overhang	OHX Max. Overhang			
DTA-D.625-7D-C	0.625	0.630	0.630	6.14	3.60	2.60	3.50	G1/8	S	1
DTA-D.625-10D-E	0.625	0.630	0.630	8.03	5.22	3.59	5.50	-	H	1
DTA-D.750-7D-C	0.750	0.787	0.787	7.87	4.94	2.93	4.40	G1/4	S	1
DTA-D.750-10D-E	0.750	0.787	0.787	10.24	6.77	4.46	7.00	-	H	1
DTA-D1.00-7D-C	1.000	0.984	0.984	10.20	6.83	3.37	6.20	G1/4	S	1
DTA-D1.00-10D-C	1.000	0.984	0.984	13.21	8.65	6.21	9.20	G1/4	S	1
DTA-D1.25-7D-C	1.250	1.260	1.260	12.48	7.37	5.15	7.50	G3/8	S	1
DTA-D1.25-10D-C	1.250	1.260	1.260	16.24	9.67	7.49	11.20	G3/8	S	1
DTA-D1.50-7D-C	1.500	1.575	1.575	15.26	9.13	6.20	9.20	G1/2	S	1
DTA-D1.50-10D-C	1.500	1.575	1.575	19.80	13.35	9.24	13.70	G1/2	S	1
DTA-D2.00-7D-C	2.000	1.575	2.000	20.74	-	6.74	12.70	G1/2	S	2
DTA-D2.00-10D-C	2.000	1.575	2.000	26.73	-	12.74	18.70	G1/2	S	2
DTA-D2.50-7D-C	2.500	1.575	2.500	26.20	-	8.74	16.20	G3/4	S	2
DTA-D2.50-10D-C	2.500	1.575	2.500	33.72	-	16.24	23.70	G3/4	S	2

(1) DCONWS dimension of bar must match DCONMS dimension of head.  
 (2) See New Product Announcement for details on cutting bars to shorter lengths.  
 (3) S-steel body, H-solid carbide body.

**Spare Parts**

Part Number	Screw	Wrench	Sleeves (Refer to page 133 for detailed dimensions)			
			1.25" OD	1.50" OD	2.00" OD	2.50" OD
DTA-D.625...	SHM3X0.5X10	L-W2.5	QSL31.8-15.9-L66	QSL38.1-15.9-L106	-	-
DTA-D.750...	SRM3.5X1.0-D5.5	L-W2.5	QSL31.8-19-L66	QSL38.1-19-L106	QSL50.8-19-L126	-
DTA-D1.00...	SHM4X0.7X12	L-W3	QSL31.8-25.4-L66	QSL38.1-25.4-L106	QSL50.8-25.4-L126	-
DTA-D1.25...	SHM5X0.8X12	L-W4	-	QSL38.1-31.8-L106	QSL50.8-31.8-L126	QSL63.5-31.8-L156
DTA-D1.50...	SHM6X1X16	L-W5	-	-	QSL50.8-38.1-L126	QSL63.5-38.1-L156
DTA-D2.00...	SHM6X1X16	L-W5	-	-	-	QSL63.5-50.8-L156
DTA-D2.50...	SHM6X1X16	L-W5	-	-	-	-





**TABSORBER™ SERIES DTA (METRIC)**

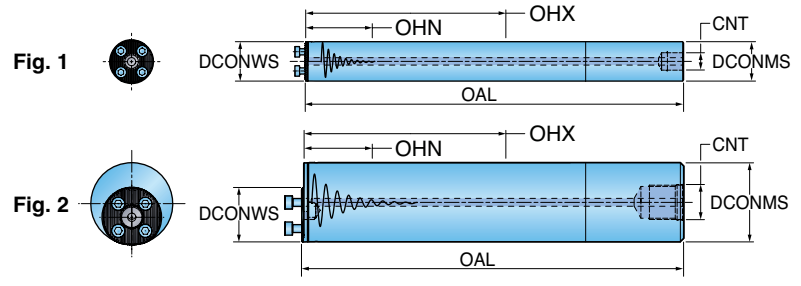

Part Number	Dimension (mm)					CNT Coolant Entry Thread Size	BMC <sup>(3)</sup> Body Material Code	Figure
	DCONMS Connection Dia. Machine Side	DCONWS <sup>(1)</sup> Connection Dia. Workpiece Side	OAL <sup>(2)</sup> Overall Length	OHN Min. Overhang	OHX Max. Overhang			
DTA-D16-7D-C	16	16	156	55	92	G1/8	S	1
DTA-D16-10D-E	16	16	204	96	140	-	H	1
DTA-D20-7D-C	20	20	200	70	120	G1/4	S	1
DTA-D20-10D-E	20	20	260	120	180	-	H	1
DTA-D25-7D-C	25	25	258	88	155	G1/4	S	1
DTA-D25-10D-C	25	25	333	155	230	G1/4	S	1
DTA-D32-7D-C	32	32	323	120	192	G3/8	S	1
DTA-D32-10D-C	32	32	419	192	288	G3/8	S	1
DTA-D40-7D-C	40	40	411	128	251	G1/2	S	1
DTA-D40-10D-C	40	40	531	248	368	G1/2	S	1
DTA-D50-7D-C	50	40	523	168	318	G1/2	S	2
DTA-D50-10D-C	50	40	673	318	468	G1/2	S	2
DTA-D60-7D-C	60	40	633	208	388	G3/4	S	2
DTA-D60-10D-C	60	40	813	388	568	G3/4	S	2

(1) DCONWS dimension of bar must match DCONMS dimension of head.  
 (2) See New Product Announcement for details on cutting bars to shorter lengths.  
 (3) S-steel body, H-solid carbide body.

**Spare Parts**

Part Number	Screw	Wrench	Sleeves (Refer to page 134 for detailed dimensions)			
			32mm OD	40mm OD	50mm OD	60mm OD
DTA-D16...	SHM3X0.5X10	L-W2.5	QSL32-16-L66	QSL40-16-L106	-	-
DTA-D20...	SRM3.5XL10-D5.5	L-W2.5	QSL32-20-L66	QSL40-20-L106	QSL50-20-L126	-
DTA-D25...	SHM4X0.7X12	L-W3	QSL32-25-L66	QSL40-25-L106	QSL50-25-L126	-
DTA-D32...	SHM5X0.8X12	L-W4	-	QSL40-32-L106	QSL50-32-L126	QSL60-32-L156
DTA-D40...	SHM6X1X16	L-W5	-	-	QSL50-40-L126	QSL60-40-L156
DTA-D50...	SHM6X1X16	L-W5	-	-	-	QSL60-50-L156
DTA-D60...	SHM6X1X16	L-W5	-	-	-	-



**TABSORBER™ SERIES DTC-HCLNR**

**HOOK LEVER TYPE BORING HEADS (CNMX INSERTS)**

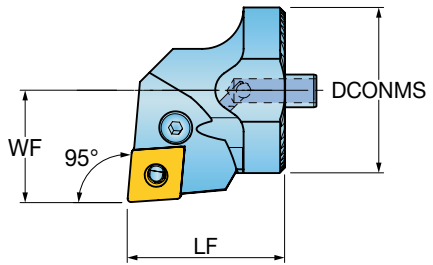
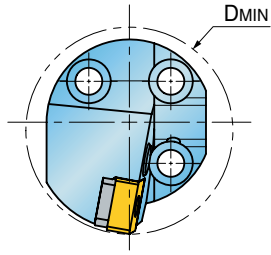

Approach angle	Part Number	Dimension (inch)				Coolant	Insert
		DCONMS Connection Dia. Machine Side	LF Functional Length	WF Functional Width	DMIN Min. Bore Dia.		
<b>93°</b> 	✓ <b>DTC-D40-HCLNR-1205</b>	1.575	1.496	1.063	1.968	Yes	CNMX43.5...

✓ Marked: For GoldDuty insert

**Spare Parts**

Part Number	Lever	Lever Screw	Shim	Shim Pin	Shim Pin Punch	Wrench
<b>HCLNR-1205</b>	LCL 12-NX	LCS 5	LSC 42-NXS	LSP 4	SPP 3-4	L-W 3

**TABSORBER™ SERIES DTC-HDUNR/L**

**HOOK LEVER TYPE BORING HEADS (DNMG INSERTS)**

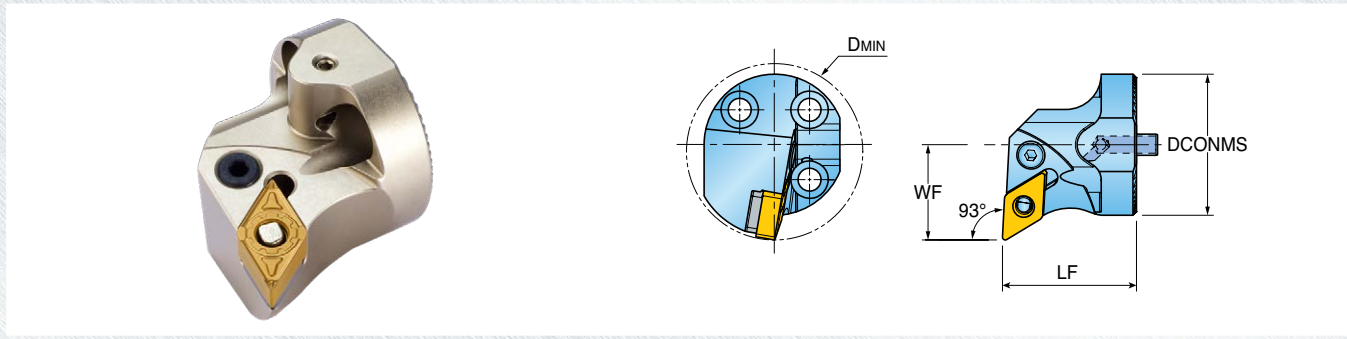

Approach angle	Part Number	Dimension (inch)				Coolant	Insert
		DCONMS Connection Dia. Machine Side	LF Functional Length	WF Functional Width	DMIN Min. Bore Dia.		
<b>93°</b> 	✓ <b>DTC-D40-HDUNR/L-1305</b>	1.575	1.496	1.063	1.968	Yes	DN_G 3.53.5...

✓ Marked: For RhinoTurn insert

**Spare Parts**

Part Number	Lever	Lever Screw	Shim	Shim Pin	Shim Pin Punch	Wrench	
<b>HDUNR/L-1305</b>	LCL 11-NX	LCS 4S	LSD 3.52B	LSP 4	SPP 3-4	L-W 3	

**TABSORBER™ SERIES DTC-HVUNR/L**

**HOOK LEVER TYPE BORING HEADS (VNMX INSERTS)**

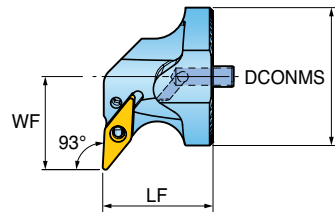
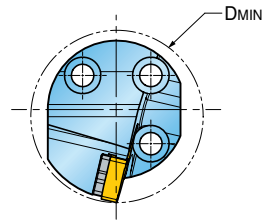

Approach angle	Part Number	Dimension (inch)				Coolant	Insert
		DCONMS Connection Dia. Machine Side	LF Functional Length	WF Functional Width	DMIN Min. Bore Dia.		
<b>93°</b> 	✓ <b>DTC-D40-HVUNR/L-1304</b>	1.575	1.256	1.063	1.968	Yes	VN_X2.53...

✓ Marked: For RhinoTurn insert

**Spare Parts**

Part Number	Lever	Lever Screw	Shim	Shim Pin	Shim Pin Punch	Wrench	
<b>HVUNR/L-1304</b>	LCL 08-NX	LCS 4-DH	LSV 2.51.8H	LSP 3B	SPP 3-3L	L-W 2.5	



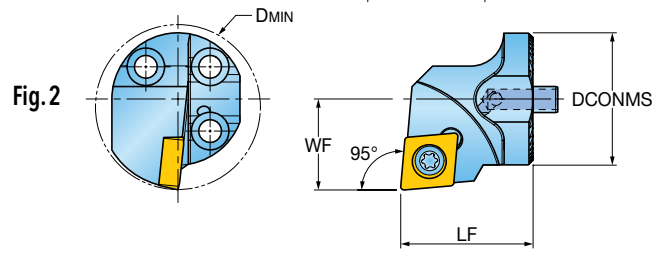
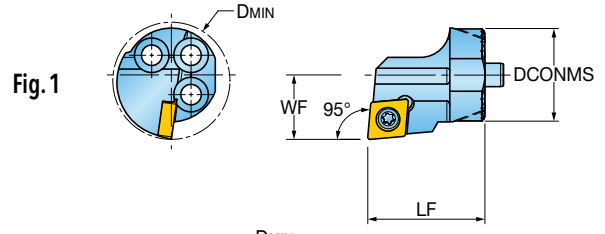

**TABSORBER™ SERIES DTC-SCLCR/L**

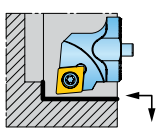
SCREW TYPE BORING HEADS (CCMT INSERTS)



Approach angle	Part Number	Dimension (inch)				Coolant	Fig.	Insert
		DCONMS Connection Dia. Machine Side	LF Functional Length	WF Functional Width	DMIN Min. Bore Dia.			
95° 	DTC-D16-SCLCR/L-06	.630	.787	.433	.787	Yes	1	CC_T21.5...
	DTC-D20-SCLCR/L-09	.787	.787	.512	.984	Yes	2	CC_T32.5...
	DTC-D25-SCLCR/L-09	.984	.787	.664	1.260	Yes	2	
	DTC-D32-SCLCR/L-12	1.260	1.260	.866	1.575	Yes	2	
	DTC-D40-SCLCR/L-12	1.575	1.496	1.063	1.968	Yes	2	CC_T43...

Spare Parts

Part Number	Screw	Shim	Shim Screw	Wrench	
					
DTC16	SO 250651	-	-	T 7	-
DTC20, DTC25	SO 350801	-	-	T 15	-
DTC32	SO 451001	-	-	T 20	-
DTC40	SO 451301	SSC 43N	SO 601055	T 20	L-W 5

**TABSORBER™ SERIES DTC-SCLNR/L**

SCREW TYPE BORING HEADS (CNMX INSERTS)

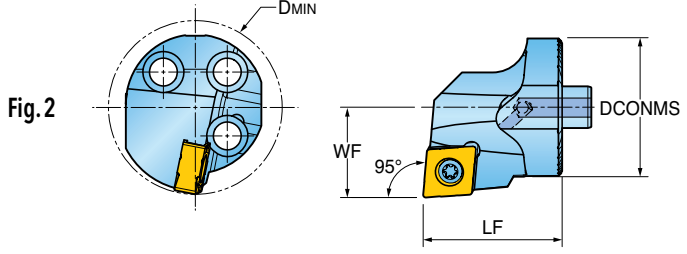
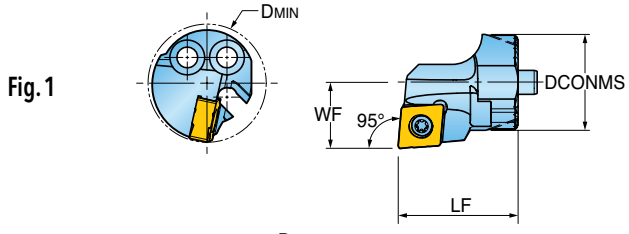

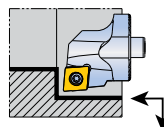
Approach angle	Part Number	Dimension (inch)				Coolant	Fig.	Insert
		DCONMS Connection Dia. Machine Side	LF Functional Length	WF Functional Width	DMIN Min. Bore Dia.			
95° 	*DTC-D16-SCLNR/L-0703	.630	.787	.433	.787	Yes	1	CN_X.2.22...
	*DTC-D20-SCLNR/L-0703	.787	.787	.512	.984	Yes	2	

\* Marked: For RhinoTurnM insert

Spare Parts

Part Number	Screw	Wrench	
			
DTC-D16...	SM25-060-90	T 7P	
DTC-20...	SM25-060-90	T 7P	

**TABSORBER™ SERIES DTC-SDUCR/L**

SCREW TYPE BORING HEADS (DCMT INSERTS)

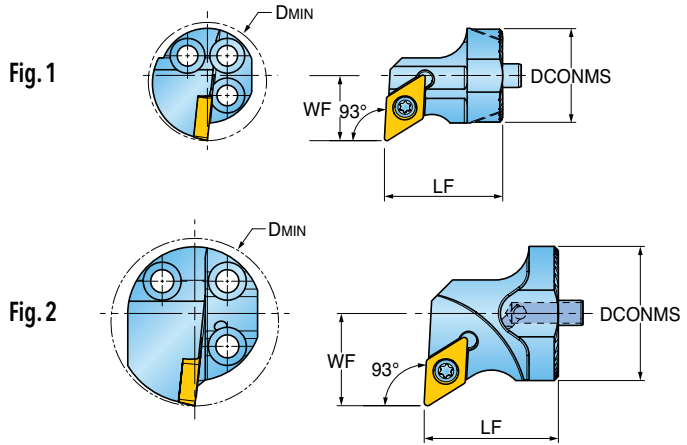

Approach angle	Part Number	Dimension (inch)				Coolant	Fig.	Insert
		DCONMS Connection Dia. Machine Side	LF Functional Length	WF Functional Width	DMIN Min. Bore Dia.			
<p>93°</p>	DTC-D16-SDUCR/L-07	.630	.787	.433	.787	Yes	1	DC_T21.5...
	DTC-D20-SDUCR/L-11	.787	.787	.512	.984	Yes	2	DC_T32.5...
	DTC-D25-SDUCR/L-11	.984	.787	.668	1.260	Yes	2	
	DTC-D32-SDUCR/L-11	1.260	1.260	.866	1.575	Yes	2	
	DTC-D40-SDUCR/L-11	1.575	1.496	1.063	1.968	Yes	2	

Spare Parts

Part Number	Screw	Shim	Shim Screw	Wrench	
DTC16	SO 25065I	-	-	T 7	-
DTC20, 25, 32	SO 35080I	-	-	T 15	-
DTC40	SO 35124I	SSD 32	SO 50090S	T 15	L-W 3.5

**TABSORBER™ SERIES DTC-SDUNR/L**

SCREW TYPE BORING HEADS (DNMX & DNMG INSERTS)

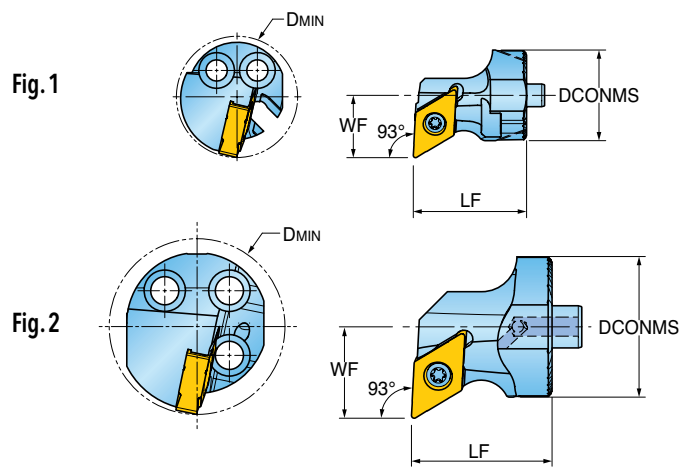

Approach angle	Part Number	Dimension (inch)				Coolant	Fig.	Insert
		DCONMS Connection Dia. Machine Side	LF Functional Length	WF Functional Width	DMIN Min. Bore Dia.			
<b>95°</b> 	*DTC-D16-SDUNR/L-0803	.630	.787	.433	.787	Yes	1	DN_X 2.22...
	*DTC-D20-SDUNR/L-0803	.787	.787	.512	.984	Yes	2	
	✓DTC-D32-SDUNR/L-1305	1.260	1.260	.866	1.575	Yes	2	DN_G 3.53.5...

\* Marked: For RhinoTurnM insert  
✓ Marked: For RhinoTurn insert

Spare Parts

Part Number	Screw	Wrench
DTC-D16, D20	SM25-060-90	T 7P
DTC-32	SM40-110-00	T 15



**TABSORBER™ SERIES DTC-SVUBR/L**

**SCREW TYPE BORING HEADS (VBMT INSERTS)**

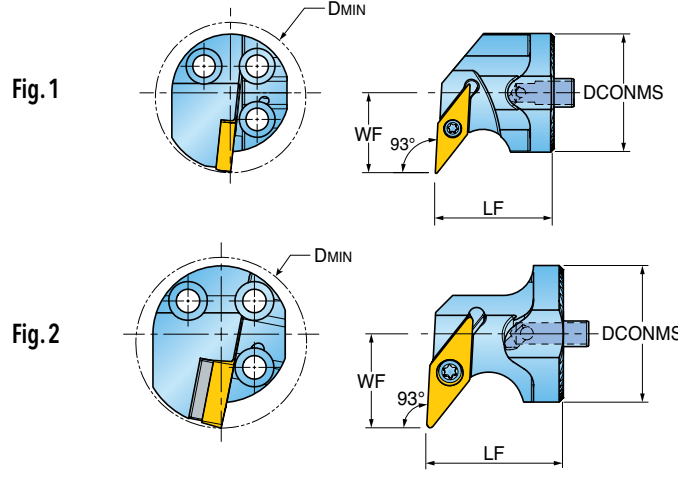

Approach angle	Part Number	Dimension (inch)				Coolant	Fig.	Insert
		DCONMS Connection Dia. Machine Side	LF Functional Length	WF Functional Width	DMIN Min. Bore Dia.			
 93°	DTC-D20-SVUBR/L-11	.787	.787	.630	1.063	Yes	1	VB_T22...
	DTC-D25-SVUBR/L-11	.984	.984	.670	1.220	Yes	1	
	DTC-D32-SVUBR/L-16	1.260	1.260	.866	1.575	Yes	2	VB_T33...
	DTC-D40-SVUBR/L-16	1.575	1.260	1.063	1.968	Yes	2	

**Spare Parts**

Part Number	Screw	Shim	Shim Screw	Wrench	
DTC-D...SVUBR/L-11	SO 250651	-	-	T 7	-
DTC-D...SVUBR/L-16	SO 35124I	SSV 32	SO 50090S	T 15	L-W 3.5

**TABSORBER™ SERIES DTC-SWLNR/L**

SCREW TYPE BORING HEADS (WNMX INSERTS)

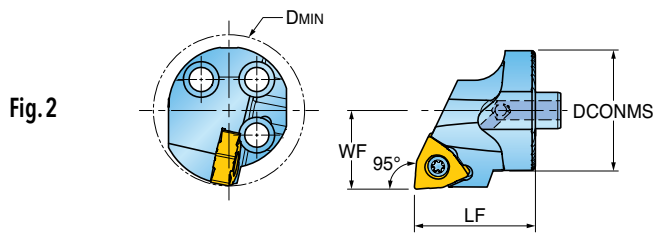
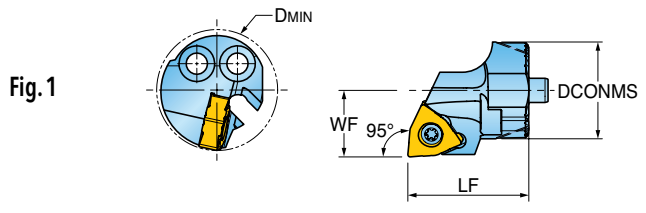

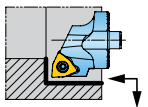
Approach angle	Part Number	Dimension (inch)				Coolant	Fig.	Insert
		DCONMS Connection Dia. Machine Side	LF Functional Length	WF Functional Width	DMIN Min. Bore Dia.			
95° 	*DTC-D16-SWLNR/L-0403	.630	.787	.433	.787	Yes	1	WN_X.2.22...
	*DTC-D20-SWLNR/L-0403	.787	.787	.512	.984	Yes	2	

\* Marked: For RhinoTurnM insert

Spare Parts

Part Number	Screw	Wrench
DTC-D...	 SM25-060-90	 T 7P



**TABSORBER™ SERIES DTC-SIR/L**

**SCREW TYPE BORING HEADS (LAYDOWN THREADING INSERTS)**

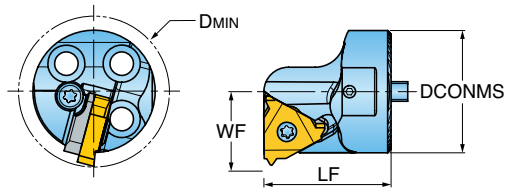

Part Number	Dimension (inch)				Coolant	Insert
	DCONMS Connection Dia. Machine Side	LF Functional Length	WF Functional Width	DMIN Min. Bore Dia.		
DTC-D25-SIR/L-16	.984	1.024	.638	1.142	Yes	16IR/L
DTC-D32-SIR/L-16	1.260	1.063	.776	1.417	Yes	16IR/L
DTC-D40-SIR/L-16	1.575	1.181	.433	1.733	Yes	16IR/L
DTC-D32-SIR/L-22	1.260	1.260	.850	1.417	Yes	22IR/L
DTC-D40-SIR/L-22	1.575	1.496	1.008	1.811	Yes	22IR/L

**Spare Parts**

Part Number	Anvil Ext.L/Int.R	Anvil Ext.R/Int.L	Anvil Screw	Wrench	Screw
DTC-D25-SIL-16	-	AE16	A16	T-10/5	S16
DTC-D25-SIR-16	AI16	-	A16	T-10/5	S16
DTC-D32-SIL-16	-	AE16	A16	T-10/5	S16
DTC-D32-SIR-16	AI16	-	A16	T-10/5	S16
DTC-D40-SIL-16	-	AE16	A16	T-10/5	S16
DTC-D40-SIR-16	AI16	-	A16	T-10/5	S16
DTC-D32-SIL-22	-	AE22	A22	T-20/5	S22
DTC-D32-SIR-22	AI22	-	A22	T-20/5	S22
DTC-D40-SIL-22	-	AE22	A22	T-20/5	S22
DTC-D40-SIR-22	AI22	-	A22	T-20/5	S22

**TABSORBER™ SERIES QSL (INCH)**

INCH SLEEVES

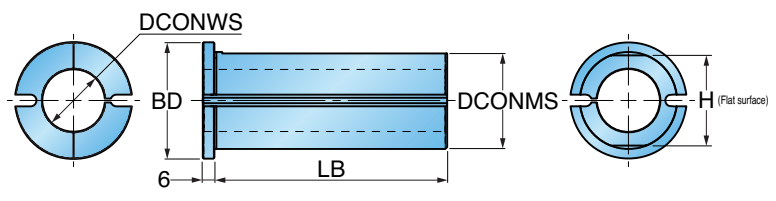

Part Number	Dimension (inch)				
	DCONMS Connection Dia. Machine Side	DCONWS Connection Dia. Work Piece Side	BD Body Diameter	LB Body Length	H Height
QSL31.8-15.9-L66	1.250	0.625	1.654	2.362	1.210
QSL31.8-19-L66	1.250	0.750	1.654	2.362	1.210
QSL31.8-25.4-L66	1.250	1.000	1.654	2.362	1.210
QSL38.1-15.9-L106	1.500	0.625	1.969	3.937	1.461
QSL38.1-19-L106	1.500	0.750	1.969	3.937	1.461
QSL38.1-25.4-L106	1.500	1.000	1.969	3.937	1.461
QSL38.1-31.8-L106	1.500	1.250	1.969	3.937	1.461
QSL50.8-19-L126	2.000	0.750	2.362	4.724	1.941
QSL50.8-25.4-L126	2.000	1.000	2.362	4.724	1.941
QSL50.8-31.8-L126	2.000	1.250	2.362	4.724	1.941
QSL50.8-38.1-L126	2.000	1.500	2.362	4.724	1.941
QSL63.5-31.8-L156	2.500	1.250	2.756	5.906	2.441
QSL63.5-38.1-L156	2.500	1.500	2.756	5.906	2.441
QSL63.5-50.8-L156	2.500	2.000	2.756	5.906	2.441

Additional Holder Options Available Upon Request:



**TABSORBER™ SERIES QSL (METRIC)**

**METRIC SLEEVES**

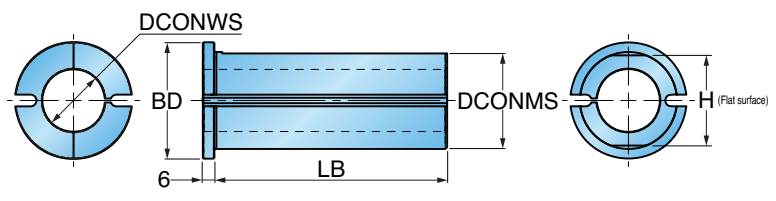

Part Number	Dimension (mm)				
	DCONMS Connection Dia. Machine Side	DCONWS Connection Dia. Work Piece Side	BD Body Diameter	LB Body Length	H Height
QSL32-16-L66	32	16	42	60	30.5
QSL32-20-L66	32	20	42	60	30.5
QSL32-25-L66	32	25	42	60	30.5
QSL40-16-L106	40	16	50	100	38.5
QSL40-20-L106	40	20	50	100	38.5
QSL40-25-L106	40	25	50	100	38.5
QSL40-32-L106	40	32	50	100	38.5
QSL50-20-L126	50	20	60	120	48.5
QSL50-25-L126	50	25	60	120	48.5
QSL50-32-L126	50	32	60	120	48.5
QSL50-40-L126	50	40	60	120	48.5
QSL60-32-L156	60	32	70	150	58.5
QSL60-40-L156	60	40	70	150	58.5
QSL60-50-L156	60	50	70	150	58.5

Additional Holder Options Available Upon Request:

