

HIPOSTRIO™

MILLING PRODUCTS



Cutter Series: (DOC)

- 1KJ1B (.13")
- 1KJ1D, KJ5D, KJ6D (.27")
- 1KJ1G, KJ5G, KJ6G (.41")
- 1KJ1P, KJ5P, KJ6P (.57")

Insert Series:

- THLS04
- THES06, THLS06
- THES10, THLS10
- THES13, THLS13

Adaptions

Cylindrical, Weldon, Top-On, ChipSurfer, Face Mill

Diameter Range:

.312" - 6.500"

Corner Geometry

- .008R, .015R, .031R,
- .062R, .094R, .125R

Materials:

Cast Iron, Aluminum, Steel, Stainless Steel, Hard Steel, High-Temp Alloys, Titanium

3-Edged HiPosTrio inserts priced like 2-Edged HiPos product equals 1 free edge!

Ingersoll's HiPosTrio line has been expanded to include a new 04 IC size insert that accommodates smaller diameter and higher density end mills...making it a great solid carbide alternative. It compliments an already superb general purpose 90° Milling line that blends performance and economy.

Features & Benefits:

- High positive cutting geometry; ideal for small machines and gummy materials
- Four insert sizes for complete cutter diameter, depth & density coverage
- Ramping capability for cutting versatility
- Inserts with integrated wiper flats typically produce surface finishes between 32-63 Ra
- Cutters ported with coolant





HIPOSTRIO™ 04 SERIES: 1KJ1B (CYLINDRICAL SHANK)

90° END MILL (4MM INSERT)

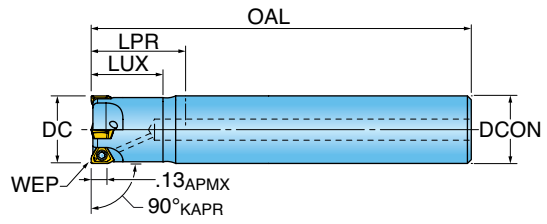
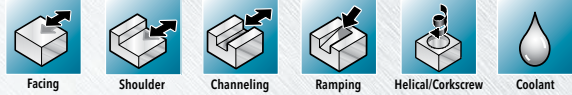

WEP - See insert drawing for wiper options.

Part Number	DC Cutting Diameter	LUX Usable Length Max.	LPR Protruding Length	OAL Overall Length	ZEFF Effective Teeth	DCON Shank Diameter	RMPX Ramp Angle Max.
1KJ1B-03006R7R01	0.312	0.62	1.58	3.00	1	0.312	2.1
1KJ1B-03007R8R01	0.375	0.75	1.58	3.00	2	0.375	2.1
1KJ1B-04007S4R01	0.437	0.75	1.22	3.00	2	0.500	3.0
1KJ1B-05008S4R01	0.500	0.87	1.72	3.50	3	0.500	2.5
1KJ1B-05010S6R01	0.562	1.00	1.59	3.50	3	0.625	2.2
1KJ1B-06010S6R01	0.625	1.00	1.59	3.50	4	0.625	1.6

*Designed with modification in mind. Extend usable length by turning back the neck diameter or shorten the overall length by cutting off back end.

HIPOSTRIO™ 04 SERIES: 1KJ1B (CHIPSURFER STYLE)

90° MODULAR END MILL (4MM INSERT)

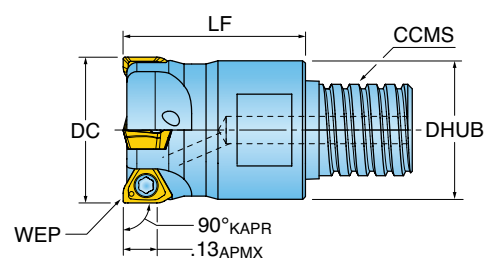
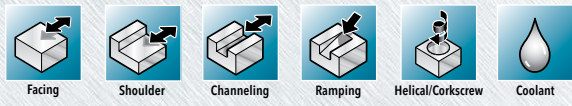

WEP - See insert drawing for wiper options.

Part Number	DC Cutting Diameter	LF Functional Length	ZEFF Effective Teeth	CCMS Connection Code	DHUB Hub Diameter	RMPX Ramp Angle Max.
1KJ1B-03006T6R01	0.375	0.63	2	Chip Surfer T06	0.36	2.1
1KJ1B-05006T8R01	0.500	0.65	3	Chip Surfer T08	0.48	2.5
1KJ1B-06008TRR01	0.625	0.80	4	Chip Surfer T10	0.60	1.6



HIPOSTRIO™ 04 SERIES: 1KJ1B (TOP•ON STYLE)

90° MODULAR END MILL (4MM INSERT)

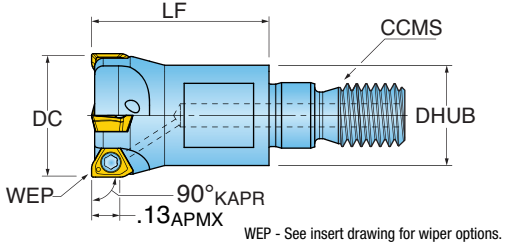

Part Number	DC Cutting Diameter	LF Functional Length	ZEFF Effective Teeth	CCMS Connection Code	DHUB Hub Diameter	RMPX Ramp Angle Max.
1KJ1B-05075X4R01	0.500	0.75	3	TopOn M06	0.46	2.5
1KJ1B-06087X5R01	0.625	0.88	4	TopOn M08	0.50	1.6

HIPOSTRIO™ 04 INSERTS



THLS04_M

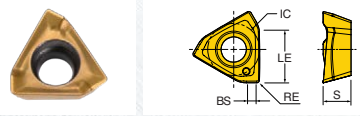

Part Number	Application	RE Corner Radius	BS Wiper Length	LE Cutting Edge Eff. Length	IC Inscribed Circle Dia.	S Thickness	IH Insert Hand	NOI Number of Indexes	Grade	IN2505	IN2530
THLS040202R-M	Multi-Purpose	0.008	0.027	0.130	0.153	0.083	Right	3		•	•
THLS040204R-M	Multi-Purpose	0.015	0.019	0.130	0.153	0.083	Right	3		•	•



HIPOSTRIO™ 04 HARDWARE

	Insert Screw	Driver	**OPTIONAL** Wrench	**OPTIONAL** Thin Wrench	**OPTIONAL** Torque Wrench	**OPTIONAL** Torque Driver Handle	**OPTIONAL** Preset Torque Bit	**OPTIONAL** Torque Driver Bit
1KJ1B-03006R7R01	SM18-041-00	DS-TP06S-NEU	-	-	-	DS-A00-.25-S	DT-05-.25	DS-TP06B
1KJ1B-03007R8R01	SM18-041-00	DS-TP06S-NEU	-	-	-	DS-A00-.25-S	DT-05-.25	DS-TP06B
1KJ1B-04007S4R01	SM18-041-00	DS-TP06S-NEU	-	-	-	DS-A00-.25-S	DT-05-.25	DS-TP06B
1KJ1B-05008S4R01	SM18-041-00	DS-TP06S-NEU	-	-	-	DS-A00-.25-S	DT-05-.25	DS-TP06B
1KJ1B-05010S6R01	SM18-041-00	DS-TP06S-NEU	-	-	-	DS-A00-.25-S	DT-05-.25	DS-TP06B
1KJ1B-06010S6R01	SM18-041-00	DS-TP06S-NEU	-	-	-	DS-A00-.25-S	DT-05-.25	DS-TP06B
1KJ1B-03006T6R01	SM18-041-00	DS-TP06S-NEU	-	WS-0029	DT-90-08	DS-A00-.25-S	DT-05-.25	DS-TP06B
1KJ1B-05006T8R01	SM18-041-00	DS-TP06S-NEU	-	WS-0030	DT-130-10	DS-A00-.25-S	DT-05-.25	DS-TP06B
1KJ1B-06008TRR01	SM18-041-00	DS-TP06S-NEU	-	WS-0044	DT-250-13	DS-A00-.25-S	DT-05-.25	DS-TP06B
1KJ1B-05075X4R01	SM18-041-00	DS-TP06S-NEU	-	-	-	DS-A00-.25-S	DT-05-.25	DS-TP06B
1KJ1B-06087X5R01	SM18-041-00	DS-TP06S-NEU	610MM	-	-	DS-A00-.25-S	DT-05-.25	DS-TP06B

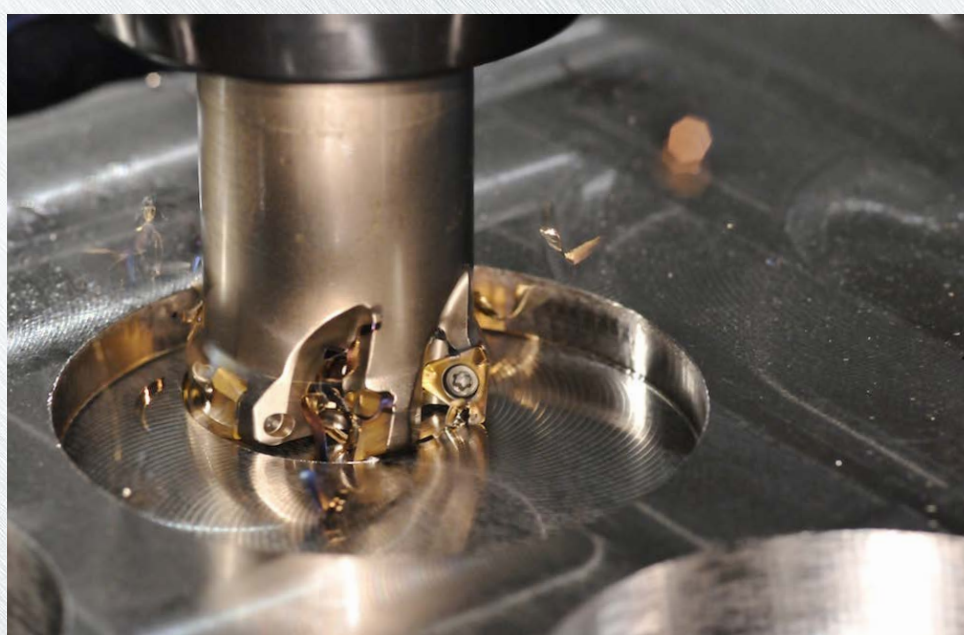



HIPOSTRIO™ 06 SERIES: 1KJ1D (WELDON SHANK)

90° END MILL (6MM INSERT)

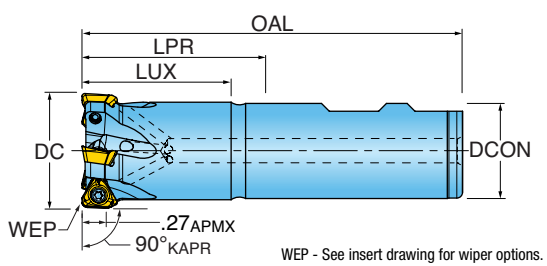
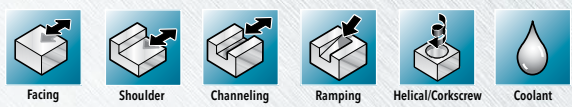

Part Number	DC Cutting Diameter	LUX Usable Length Max.	LPR Protruding Length	OAL Overall Length	ZEFF Effective Teeth	DCON Shank Diameter	CSP Coolant	RMPX Ramp Angle Max.
1KJ1D-0601279R01	0.625	1.22	1.25	3.25	1	0.625	Yes	4
1KJ1D-0702084R01	0.725	1.80	2.00	4.00	2	0.750	Yes	3.1
1KJ1D-0701184R01	0.750	1.05	1.25	3.25	2	0.750	Yes	3.1
1KJ1D-0701784R01	0.750	1.55	1.75	3.75	2	0.750	Yes	3.1
1KJ1D-0703084R01	0.750	2.80	3.00	5.00	2	0.750	Yes	3.1
1KJ1D-0801784R01	0.875	1.75	1.75	3.75	2	0.750	Yes	2.5
1KJ1D-1001780R01	1.000	1.55	1.75	4.00	3	1.000	Yes	2.1
1KJ1D-1001784R01	1.000	1.75	1.75	3.75	3	0.750	Yes	2.1
1KJ1D-1003780R01	1.000	3.38	3.75	6.00	3	1.000	Yes	2.1
1KJ1D-1003784R01	1.000	3.55	3.75	6.00	3	0.750	Yes	2.1
1KJ1D-1201780R01	1.250	1.75	1.75	4.00	5	1.000	Yes	1.5
1KJ1D-1201784R01	1.250	1.75	1.75	3.75	4	0.750	Yes	1.5
1KJ1D-1501780R01	1.500	1.75	1.75	4.00	6	1.000	Yes	1.3
1KJ1D-1501784R01	1.500	1.75	1.75	3.75	5	0.750	Yes	1.3
1KJ1D-1502281R01	1.500	2.25	2.25	4.50	6	1.250	Yes	1.3



HIPOSTRIO™ 06 SERIES: 1KJ1D (TOPON M-ADAPTION)

90° MODULAR END MILL (6MM INSERT)

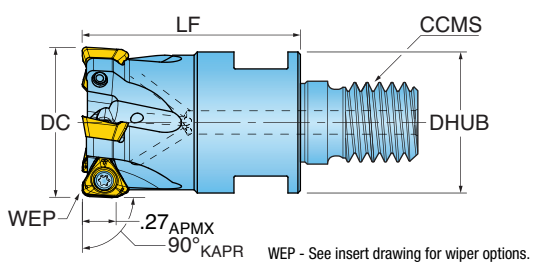
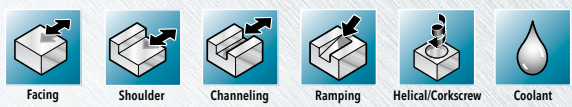

Part Number	DC Cutting Diameter	LF Functional Length	ZEFF Effective Teeth	CCMS Connection Code	DHUB Hub Diameter	CSP Coolant	RMPX Ramp Angle Max.
1KJ1D-07015X6R01	0.750	1.50	2	TopOn M10	.69	Yes	3.1
1KJ1D-10015X7R01	1.000	1.50	2	TopOn M12	.81	Yes	2.1
1KJ1D-10015X7R02	1.000	1.50	3	TopOn M12	.81	Yes	2.1
1KJ1D-12017X8R02	1.250	1.75	5	TopOn M16	1.13	Yes	1.5
1KJ1D-15017X8R01	1.500	1.75	5	TopOn M16	1.13	Yes	1.3

HIPOSTRIO™ 06 SERIES: KJ5D, KJ6D

90° FACE MILL (6MM INSERT)

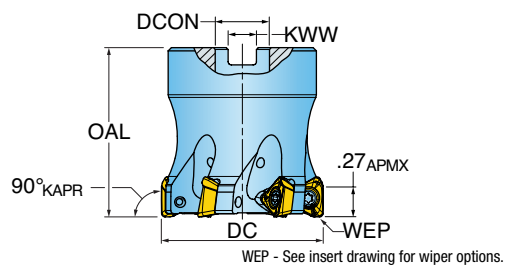
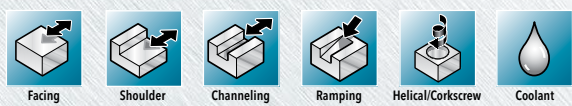

Part Number	DC Cutting Diameter	OAL Overall Length	ZEFF Effective Teeth	DCON Bore Diameter	KWW Keyway	CSP Coolant	RMPX Ramp Angle Max.
KJ5D-15R01	1.500	1.57	6	0.500	0.250	Yes	1.3
KJ5D-20R01	2.000	1.57	7	0.750	0.312	Yes	1.2
KJ6D-30R01	3.000	1.75	9	1.000	0.375	Yes	.4





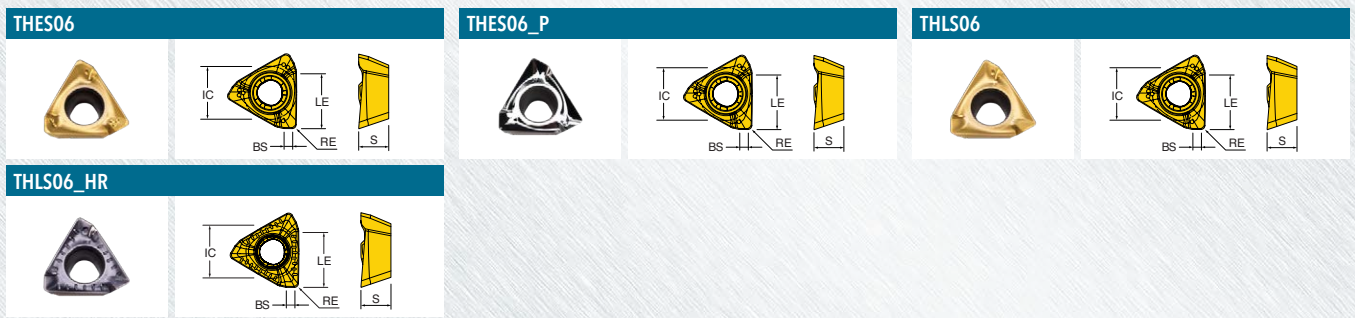
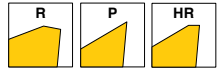





HIPOSTRIO™ 06 INSERTS



Part Number	Application	RE Corner Radius	BS Wiper Length	LE Cutting Edge Length	IC Inscribed Circle Diameter	S Thickness	NOI Number of Indexes	Grade	IN10K	IN2035	IN2504	IN2505	IN2510	IN2530	IN2540	IN4030
THES060404R	Multi-Purpose; Ground Periphery	0.015 R	0.051	0.270	0.272	0.157	3					•				
THES060408R	Multi-Purpose; Ground Periphery	0.031 R	0.035	0.270	0.272	0.157	3					•				
THES060404FR-P	Grd/Pol for Al	0.015 R	0.051	0.270	0.272	0.157	3	•								
THES060408FR-P	Grd/Pol for Al	0.031 R	0.035	0.270	0.272	0.157	3	•								
THLS060404R	Multi-Purpose	0.015 R	0.051	0.270	0.272	0.157	3				•	•	•	•		
THLS060408R	Multi-Purpose	0.031 R	0.035	0.270	0.272	0.157	3				•	•	•	•	•	•
THLS060416R	Multi-Purpose	0.062 R	0.022	0.270	0.272	0.157	3				•	•				
THLS060404R-HR	SS/Hi-Temp/Ti	0.015 R	0.051	0.270	0.272	0.157	3			•						
THLS060408R-HR	SS/Hi-Temp/Ti	0.031 R	0.035	0.270	0.272	0.157	3			•	•			•		

HIPOSTRIO™ 06 HARDWARE

								
	Insert Screw	Screw Driver	Retention Bolt	Retention Bolt w/Coolant	Wrench	**OPTIONAL**	**OPTIONAL**	**OPTIONAL**
1KJ1D-0601279R01	SM25-065-R0	DS-T08W	-	-	-	DS-A00-.25-S	DT-11-.25	DS-TP08B
1KJ1D-0702084R01	SM25-065-R0	DS-T08W	-	-	-	DS-A00-.25-S	DT-11-.25	DS-TP08B
1KJ1D-0701184R01	SM25-065-R0	DS-T08W	-	-	-	DS-A00-.25-S	DT-11-.25	DS-TP08B
1KJ1D-0701784R01	SM25-065-R0	DS-T08W	-	-	-	DS-A00-.25-S	DT-11-.25	DS-TP08B
1KJ1D-0703084R01	SM25-065-R0	DS-T08W	-	-	-	DS-A00-.25-S	DT-11-.25	DS-TP08B
1KJ1D-0801784R01	SM25-065-R0	DS-T08W	-	-	-	DS-A00-.25-S	DT-11-.25	DS-TP08B
1KJ1D-1001780R01	SM25-065-R0	DS-T08W	-	-	-	DS-A00-.25-S	DT-11-.25	DS-TP08B
1KJ1D-1001784R01	SM25-065-R0	DS-T08W	-	-	-	DS-A00-.25-S	DT-11-.25	DS-TP08B
1KJ1D-1003780R01	SM25-065-R0	DS-T08W	-	-	-	DS-A00-.25-S	DT-11-.25	DS-TP08B
1KJ1D-1003784R01	SM25-065-R0	DS-T08W	-	-	-	DS-A00-.25-S	DT-11-.25	DS-TP08B
1KJ1D-1201780R01	SM25-065-R0	DS-T08W	-	-	-	DS-A00-.25-S	DT-11-.25	DS-TP08B
1KJ1D-1201784R01	SM25-065-R0	DS-T08W	-	-	-	DS-A00-.25-S	DT-11-.25	DS-TP08B
1KJ1D-1501780R01	SM25-065-R0	DS-T08W	-	-	-	DS-A00-.25-S	DT-11-.25	DS-TP08B
1KJ1D-1501784R01	SM25-065-R0	DS-T08W	-	-	-	DS-A00-.25-S	DT-11-.25	DS-TP08B
1KJ1D-1502281R01	SM25-065-R0	DS-T08W	-	-	-	DS-A00-.25-S	DT-11-.25	DS-TP08B
1KJ1D-07015X6R01	SM25-065-R0	DS-T08W	-	-	615MM	DS-A00-.25-S	DT-11-.25	DS-TP08B
1KJ1D-10015X7R01	SM25-065-R0	DS-T08W	-	-	617MM	DS-A00-.25-S	DT-11-.25	DS-TP08B
1KJ1D-10015X7R02	SM25-065-R0	DS-T08W	-	-	617MM	DS-A00-.25-S	DT-11-.25	DS-TP08B
1KJ1D-12017X8R02	SM25-065-R0	DS-T08W	-	-	622MM	DS-A00-.25-S	DT-11-.25	DS-TP08B
1KJ1D-15017X8R01	SM25-065-R0	DS-T08W	-	-	622MM	DS-A00-.25-S	DT-11-.25	DS-TP08B
KJ5D-15R01	SM25-065-R0	DS-T08W	SD-04-46	-	-	DS-A00-.25-S	DT-11-.25	DS-TP08B
KJ5D-20R01	SM25-065-R0	DS-T08W	SD-06-46	SD-06-89	-	DS-A00-.25-S	DT-11-.25	DS-TP08B
KJ6D-30R01	SM25-065-R0	DS-T08W	SD-08-46	SD-08-92	-	DS-A00-.25-S	DT-11-.25	DS-TP08B



HIPOSTRIO™ 10 SERIES: 1KJ1G (WELDON SHANK)

90° END MILL (10MM INSERT)

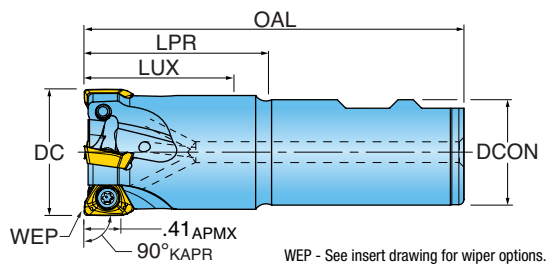
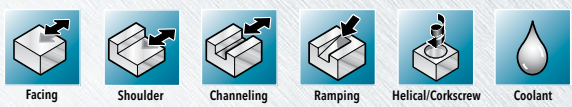

Part Number	DC Cutting Diameter	LUX Usable Length Max.	LPR Protruding Length	OAL Overall Length	ZEFF Effective Teeth	DCON Shank Diameter	CSP Coolant	RMPX Ramp Angle Max.
1KJ1G-1201784R01	1.250	1.75	1.75	3.75	3	0.750	Yes	2.3
1KJ1G-1202281R01	1.250	2.05	2.25	4.50	2	1.250	Yes	2.3
1KJ1G-1202281R02	1.250	2.05	2.25	4.50	3	1.250	Yes	2.3
1KJ1G-1204281R01	1.250	4.05	4.25	6.50	3	1.250	Yes	0
1KJ1G-1502281R01	1.500	2.20	2.25	4.50	3	1.250	Yes	1.8
1KJ1G-1502281R02	1.500	2.20	2.25	4.50	4	1.250	Yes	1.8
1KJ1G-1504281R01	1.500	4.25	4.25	6.50	3	1.250	Yes	0
1KJ1G-2002281R01	2.000	2.25	2.25	4.50	5	1.250	Yes	1.5

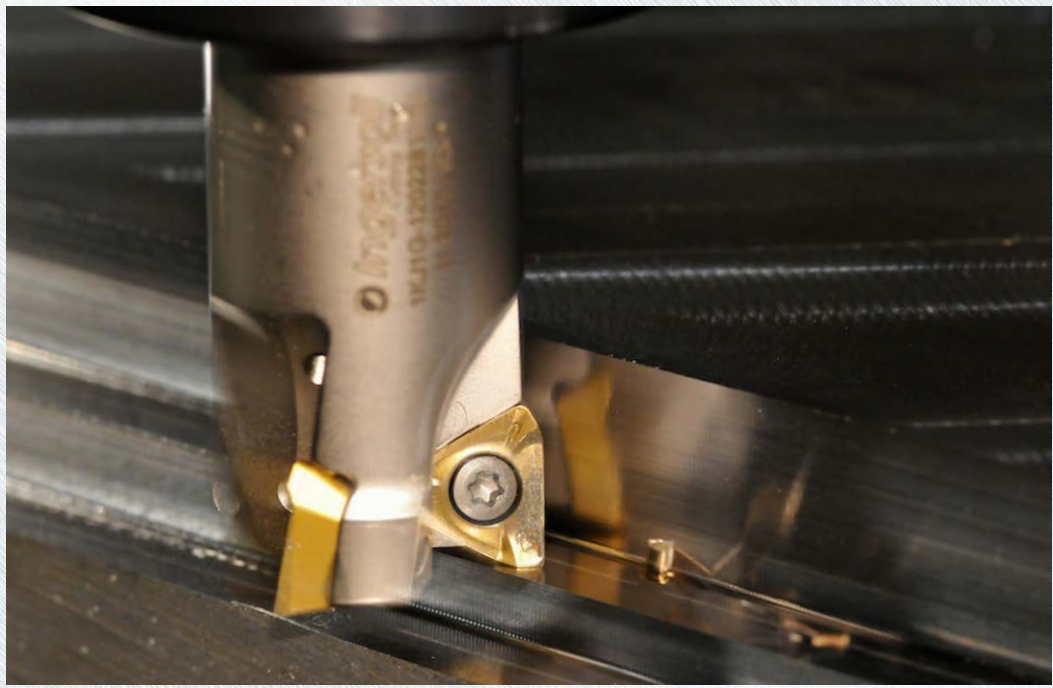



HIPOSTRIO™ 10 SERIES: 1KJ1G (TOPON M-ADAPTION)

90° MODULAR END MILL (10MM INSERT)

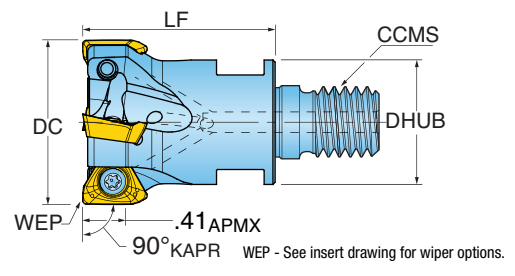
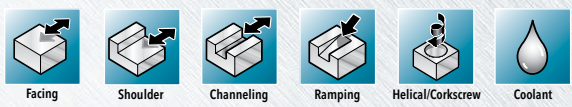

Part Number	DC Cutting Diameter	LF Functional Length	ZEFF Effective Teeth	CCMS Connection Code	DHUB Hub Diameter	CSP Coolant	RMPX Ramp Angle Max.
1KJ1G-12017X8R01	1.250	1.50	3	TopOn M16	1.13	Yes	2.3
1KJ1G-15017X8R01	1.500	1.75	4	TopOn M16	1.13	Yes	1.8

HIPOSTRIO™ 10 SERIES: KJ5G, KJ6G

90° FACE MILL (10MM INSERT)

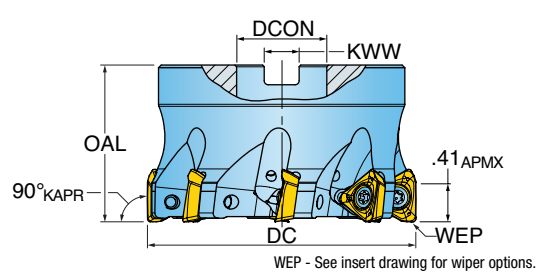
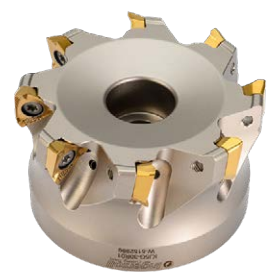
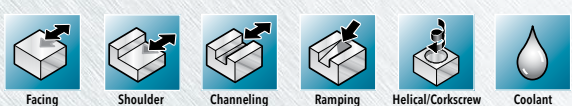

Part Number	DC Cutting Diameter	OAL Overall Length	ZEFF Effective Teeth	DCON Bore Diameter	KWW Keyway	CSP Coolant	RMPX Ramp Angle Max.
KJ6G-15R01	1.500	1.375	4	0.500	0.250	Yes	1.4
KJ5G-20R01	2.000	1.570	5	0.750	0.312	Yes	1.5
KJ6G-20R01	2.000	1.570	3	0.750	0.312	Yes	.8
KJ5G-25R01	2.500	1.570	6	0.750	0.312	Yes	1.1
KJ5G-30R01	3.000	1.750	8	1.000	0.375	Yes	.8
KJ6G-30R01	3.000	1.750	5	1.000	0.375	Yes	.8
KJ6G-30R02	3.000	1.750	3	1.000	0.375	Yes	.8
KJ5G-40R02	4.000	2.375	10	1.500	0.625	Yes	.6
KJ6G-40R02	4.000	2.375	8	1.500	0.625	Yes	.6
KJ6G-50R02	5.000	2.375	11	1.500	0.625	Yes	.5



HIPOSTRIO™ 10 INSERTS

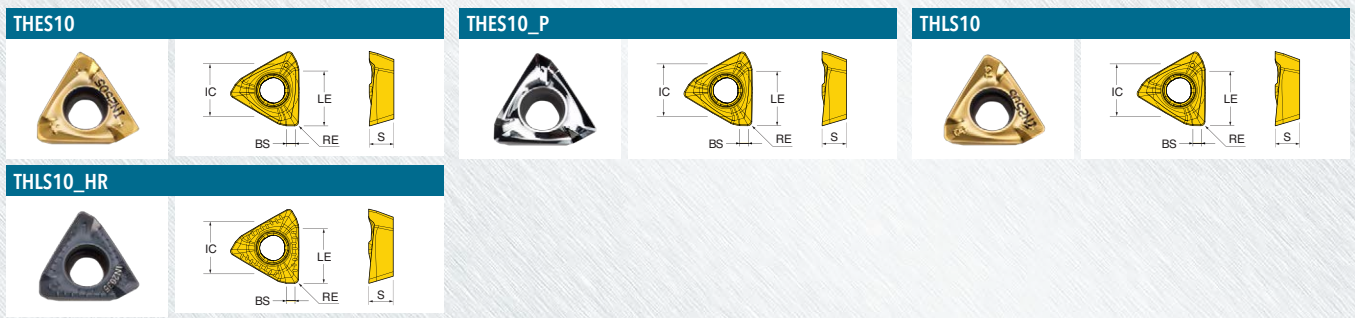
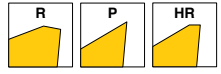

Part Number	Application	RE Corner Radius	BS Wiper Length	LE Cutting Edge Length	IC Inscribed Circle Diameter	S Thickness	NOI Number of Indexes	Grade	INTOK	IN2035	IN2504	IN2505	IN2510	IN2530	IN2540	IN4030
THES100504R	Multi-Purpose; Ground Periphery	0.015 R	0.078	0.430	0.421	0.197	3					•				
THES100508R	Multi-Purpose; Ground Periphery	0.031 R	0.062	0.430	0.421	0.197	3					•				
THES100516R	Multi-Purpose; Ground Periphery	0.062 R	0.031	0.430	0.421	0.197	3					•				
THES100504FR-P	Grd/Pol for Al	0.015 R	0.078	0.430	0.421	0.197	3	•								
THES100508FR-P	Grd/Pol for Al	0.031 R	0.062	0.430	0.421	0.197	3	•								
THLS100508R	Multi-Purpose	0.031 R	0.062	0.430	0.421	0.197	3			•	•	•	•	•	•	•
THLS100516R	Multi-Purpose	0.062 R	0.031	0.430	0.421	0.197	3				•	•				
THLS100524R	Multi-Purpose	0.094 R	0.020	0.430	0.421	0.197	3					•				
THLS100508R-HR	SS/Hi-Temp/Ti	0.031 R	0.062	0.430	0.421	0.197	3			•		•		•		

HIPOSTRIO™ 10 HARDWARE

	Insert Screw	Driver Handle	Torx Driver Blade	Retention Bolt	Retention Bolt w/Coolant	Wrench	**OPTIONAL**	**OPTIONAL**	**OPTIONAL**
1KJ1G-1201784R01	SM40-100-R0	DS-A00T	DS-T156B	-	-	-	DS-A00-.25-T	DS-T15B1	DT-35-.25
1KJ1G-1202281R01	SM40-100-R0	DS-A00T	DS-T156B	-	-	-	DS-A00-.25-T	DS-T15B1	DT-35-.25
1KJ1G-1202281R02	SM40-100-R0	DS-A00T	DS-T156B	-	-	-	DS-A00-.25-T	DS-T15B1	DT-35-.25
1KJ1G-1204281R01	SM40-100-R0	DS-A00T	DS-T156B	-	-	-	DS-A00-.25-T	DS-T15B1	DT-35-.25
1KJ1G-1502281R01	SM40-100-R0	DS-A00T	DS-T156B	-	-	-	DS-A00-.25-T	DS-T15B1	DT-35-.25
1KJ1G-1502281R02	SM40-100-R0	DS-A00T	DS-T156B	-	-	-	DS-A00-.25-T	DS-T15B1	DT-35-.25
1KJ1G-1504281R01	SM40-100-R0	DS-A00T	DS-T156B	-	-	-	DS-A00-.25-T	DS-T15B1	DT-35-.25
1KJ1G-2002281R01	SM40-100-R0	DS-A00T	DS-T156B	-	-	-	DS-A00-.25-T	DS-T15B1	DT-35-.25
1KJ1G-12017X8R01	SM40-100-R0	DS-A00T	DS-T156B	-	-	622MM	DS-A00-.25-T	DS-T15B1	DT-35-.25
1KJ1G-15017X8R01	SM40-100-R0	DS-A00T	DS-T156B	-	-	622MM	DS-A00-.25-T	DS-T15B1	DT-35-.25
KJ6G-15R01	SM40-100-R0	DS-A00T	DS-T156B	SE04-15	-	-	DS-A00-.25-T	DS-T15B1	DT-35-.25
KJ5G-20R01	SM40-100-R0	DS-A00T	DS-T156B	SD-06-46	SD-06-89	-	DS-A00-.25-T	DS-T15B1	DT-35-.25
KJ6G-20R01	SM40-100-R0	DS-A00T	DS-T156B	SD-06-46	SD-06-89	-	DS-A00-.25-T	DS-T15B1	DT-35-.25
KJ5G-25R01	SM40-100-R0	DS-A00T	DS-T156B	SD-06-46	SD-06-89	-	DS-A00-.25-T	DS-T15B1	DT-35-.25
KJ5G-30R01	SM40-100-R0	DS-A00T	DS-T156B	SD-08-46	SD-08-92	-	DS-A00-.25-T	DS-T15B1	DT-35-.25
KJ6G-30R01	SM40-100-R0	DS-A00T	DS-T156B	SD-08-46	SD-08-92	-	DS-A00-.25-T	DS-T15B1	DT-35-.25
KJ6G-30R02	SM40-100-R0	DS-A00T	DS-T156B	SD-08-46	SD-08-92	-	DS-A00-.25-T	DS-T15B1	DT-35-.25
KJ5G-40R01	SM40-100-R0	DS-A00T	DS-T156B	SD-12-89	SD-12-99	-	DS-A00-.25-T	DS-T15B1	DT-35-.25
KJ6G-40R01	SM40-100-R0	DS-A00T	DS-T156B	SD-12-89	SD-12-99	-	DS-A00-.25-T	DS-T15B1	DT-35-.25
KJ6G-50R01	SM40-100-R0	DS-A00T	DS-T156B	SD-12-89	SD-12-99	-	DS-A00-.25-T	DS-T15B1	DT-35-.25



HIPOSTRIO™ 13 SERIES: 1KJ1P (WELDON SHANK)

90° END MILL (13MM INSERT)

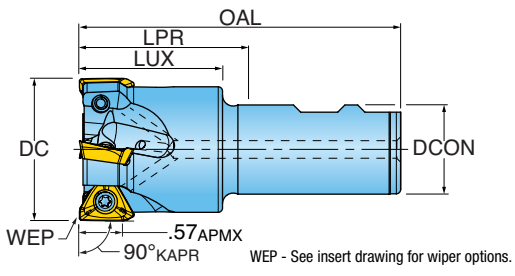
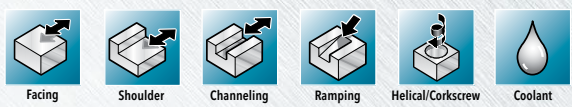

Part Number	DC Cutting Diameter	LUX Usable Length Max.	LPR Protruding Length	OAL Overall Length	ZEFF Effective Teeth	DCON Shank Diameter	CSP Coolant	RMPX Ramp Angle Max.
1KJ1P-2002281R01	2.000	2.00	2.25	4.50	4	1.250	Yes	1.5

HIPOSTRIO™ 13 SERIES: KJ5P, KJ6P

90° FACE MILL (13MM INSERT)

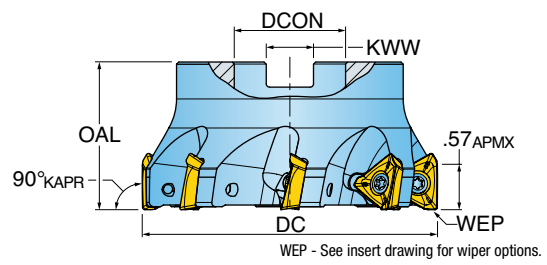
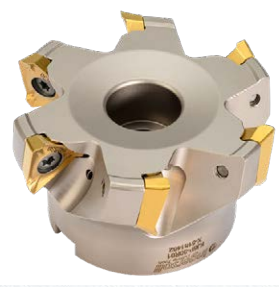
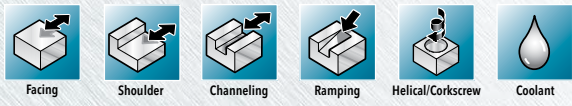

Part Number	DC Cutting Diameter	OAL Overall Length	ZEFF Effective Teeth	DCON Bore Diameter	KWW Keyway	CSP Coolant	RMPX Ramp Angle Max.
KJ5P-20R01	2.000	1.750	5	.750	0.312	Yes	1.5
KJ6P-20R01	2.000	1.750	4	.750	0.312	Yes	1.5
KJ5P-25R01	2.500	1.750	6	.750	0.312	Yes	1.5
KJ5P-30R01	3.000	1.750	7	1.000	0.375	Yes	1.0
KJ6P-30R01	3.000	1.750	6	1.000	0.375	Yes	1.0
KJ5P-40R02	4.000	2.375	8	1.500	0.625	Yes	.7
KJ6P-40R02	4.000	2.375	6	1.500	0.625	Yes	.7
KJ6P-50R02	5.000	2.000	9	1.500	0.625	Yes	.8
KJ5P-60R01	6.000	2.000	12	1.500	0.625	No	.6
KJ6P-60R01	6.000	2.000	8	1.500	0.625	No	.6
KJ6P-65R01	6.500	2.000	10	1.500	0.625	No	.4

* Ideal for Boring Mills with a 6.0 Quill.



HIPOSTRIO™ 13 INSERTS

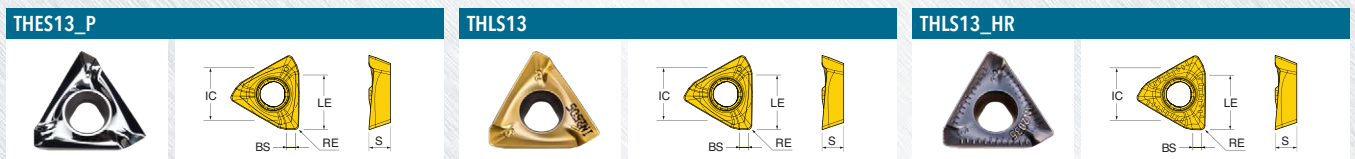
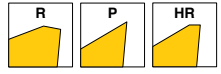

Part Number	Application	RE Corner Radius	BS Wiper Length	LE Cutting Edge Length	IC Inscribed Circle Diameter	S Thickness	NOI Number of Indexes	Grade	IN10K	IN2035	IN2505	IN2510	IN2530	IN2540	IN4030
THES130604FR-P	Grd/Pol for Al	0.015 R	0.078	0.590	0.531	0.236	3	•							
THES130608FR-P	Grd/Pol for Al	0.031 R	0.078	0.590	0.531	0.236	3	•							
THLS130608R	Multi-Purpose	0.031 R	0.078	0.590	0.531	0.236	3			•	•	•	•	•	
THLS130616R	Multi-Purpose	0.062 R	0.047	0.590	0.531	0.236	3			•		•			
THLS130624R	Multi-Purpose	0.094 R	0.024	0.590	0.531	0.236	3			•					
THLS130632R	Multi-Purpose	0.125 R	0.020	0.590	0.531	0.236	3			•					
THLS130608R-HR	SS/Hi-Temp/Ti	0.031 R	0.078	0.590	0.531	0.236	3			•	•		•		
THLS130616R-HR	SS/Hi-Temp/Ti	0.062 R	0.047	0.590	0.531	0.236	3			•					
THLS130624R-HR	SS/Hi-Temp/Ti	0.094 R	0.024	0.590	0.531	0.236	3			•					
THLS130632R-HR	SS/Hi-Temp/Ti	0.125 R	0.020	0.590	0.531	0.236	3			•					

HIPOSTRIO™ 13 HARDWARE

	Insert Screw	Driver Handle	Torx Driver Blade	Retention Bolt	Retention Bolt w/Coolant	**OPTIONAL** Torque Driver Handle	**OPTIONAL** Torque Driver Bit	**OPTIONAL** Preset Torque Bit
1KJ1P-2002281R01	SM45-120-R0	DS-A00T	DS-T206B	-	-	DS-A00-.25-T	DS-T20B1	DT-44-.25
KJ5P-20R01	SM45-100-R0	DS-A00T	DS-T206B	SB-04-15	-	DS-A00-.25-T	DS-T20B1	DT-44-.25
KJ6P-20R01	SM45-100-R0	DS-A00T	DS-T206B	SB-04-15	-	DS-A00-.25-T	DS-T20B1	DT-44-.25
KJ5P-25R01	SM45-120-R0	DS-A00T	DS-T206B	SD-06-47	SD-06-89	DS-A00-.25-T	DS-T20B1	DT-44-.25
KJ5P-30R01	SM45-120-R0	DS-A00T	DS-T206B	SD-08-47	SD-08-92	DS-A00-.25-T	DS-T20B1	DT-44-.25
KJ6P-30R01	SM45-120-R0	DS-A00T	DS-T206B	SD-08-46	SD-08-92	DS-A00-.25-T	DS-T20B1	DT-44-.25
KJ5P-40R02	SM45-120-R0	DS-A00T	DS-T206B	-	SD-12-99	DS-A00-.25-T	DS-T20B1	DT-44-.25
KJ6P-40R02	SM45-120-R0	DS-A00T	DS-T206B	-	SD-12-99	DS-A00-.25-T	DS-T20B1	DT-44-.25
KJ6P-50R02	SM45-120-R0	DS-A00T	DS-T206B	-	SD-12-99	DS-A00-.25-T	DS-T20B1	DT-44-.25
KJ5P-60R01	SM45-120-R0	DS-A00T	DS-T206B	-	-	DS-A00-.25-T	DS-T20B1	DT-44-.25
KJ6P-60R01	SM45-120-R0	DS-A00T	DS-T206B	-	-	DS-A00-.25-T	DS-T20B1	DT-44-.25
KJ6P-65R01	SM45-120-R0	DS-A00T	DS-T206B	-	-	DS-A00-.25-T	DS-T20B1	DT-44-.25



HIPOSTRIO™ 04 OPERATING GUIDELINES

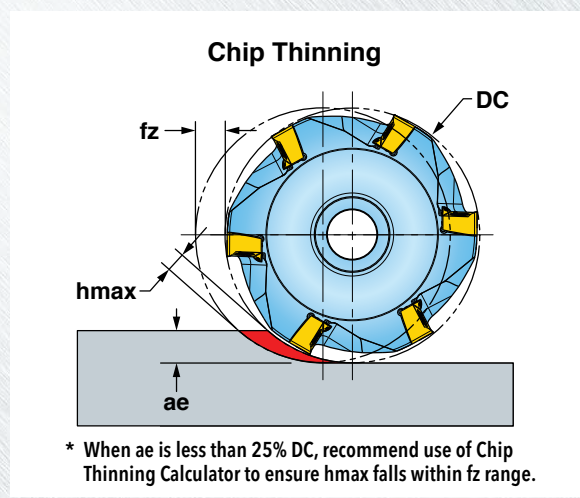

ISO	Materials			Vc Cutting Speed SFM	fz* Feed/Tooth (inch)	Harder..... Tougher		Coolant
	Mat'l Group #VDI 3323	Type	Examples			IN2505	IN2530	
P	1 thru 5	Non-alloy Steel	1018, A36, 1045, A572, 1070	400-1000	.0015-.0030	2	1	No
	6 thru 9	Low-alloy Steel	4140, 4340, P20, 8620, 300M	350-700				
	10, 11	High-alloy Steel	H13, A2, D2, M2, T1	300-600				
M	12 thru 13	Stainless Steel (Ferritic & Martensitic)	410, 416, 440	350-600	.0015-.0030	2	1	Yes
	14	Stainless Steel (Austenitic)	303, 304, 316, 15-5, 17-4	300-550				May not be required at high speeds
K	15 thru 16	Gray Cast Iron	CLS. 20, 30, 45	500-1000	.0015-.0035	1		No
	17 thru 20	Nodular Cast Iron	60-40-18, 100-70-03	400-800				
S	31 thru 35	High-Temp Alloys	Inconel, Hastelloy, Nimonic, Monel	65-200	.0015-.0030	1	2	Yes
	36 thru 37	Titanium Alloys	6Al-4V, 5Al-5Mo-5V-3Cr	85-200				

Note: Feed and speed recommendations are starting operating parameters. They are only guidelines from which further optimization should take place. Operating parameters are influenced by many machining variables. These variables may cause for reductions in feeds and speed or dramatic increases. Additionally, DOC and WOC may need to be revised to optimize the tools performance.



HIPOSTRIO™ 06 OPERATING GUIDELINES

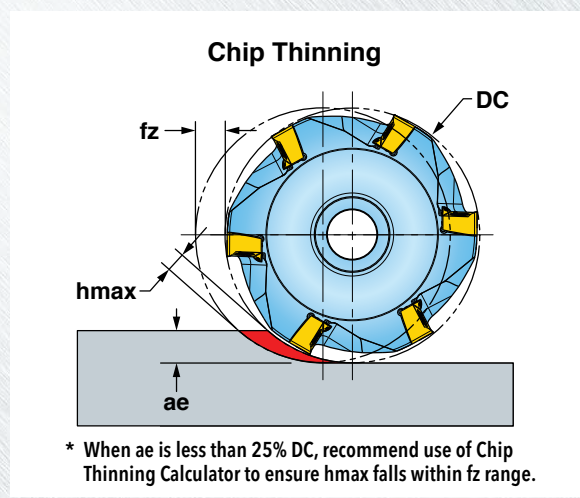

ISO	Materials			Vc Cutting Speed SFM	fz* Feed/Tooth (inch)	Harder.....Tougher						Coolant	
	Mat'l Group #VDI 3323	Type	Examples			IN2504	IN2540	IN10K	IN2510	IN2505	IN4030 IN2530		IN2035
P	1 thru 5	Non-alloy Steel	1018, A36, 1045, A572, 1070	400-1000	.003-.006								No
	6 thru 9	Low-alloy Steel	4140, 4340, P20, 8620, 300M	350-700		3			2	1			
	10, 11	High-alloy Steel	H13, A2, D2, M2, T1	300-600									
M	12 thru 13	Stainless Steel (Fer- ritic & Martensitic)	410, 416, 440	350-600	.003-.005		3		2	1		Yes	
	14	Stainless Steel (Austenitic)	303, 304, 316, 15-5, 17-4	300-550								1	
K	15 thru 16	Gray Cast Iron	CLS. 20, 30, 45	500-1000	.003-.006							No	
	17 thru 20	Nodular Cast Iron	60-40-18, 100-70-03	400-800		2		1	3				
N	21 - 30	Aluminum	7075, 6061		.003-.007			1				Yes	
S	31 thru 35	High-Temp Alloys	Inconel, Hastelloy, Nimonic, Monel	65-200	.003-.005					2	3	1	Yes
	36 thru 37	Titanium Alloys	6Al-4V, 5Al-5Mo-5V-3Cr	85-200						3	2	1	
H	38 thru 39	Hardened Steel >48	A2, O1, D2	130-250	.002-.004	1				2			No

Note: Feed and speed recommendations are starting operating parameters. They are only guidelines from which further optimization should take place. Operating parameters are influenced by many machining variables. These variables may cause for reductions in feeds and speed or dramatic increases. Additionally, DOC and WOC may need to be revised to optimize the tools performance.



HIPOSTRIO™ 10 OPERATING GUIDELINES

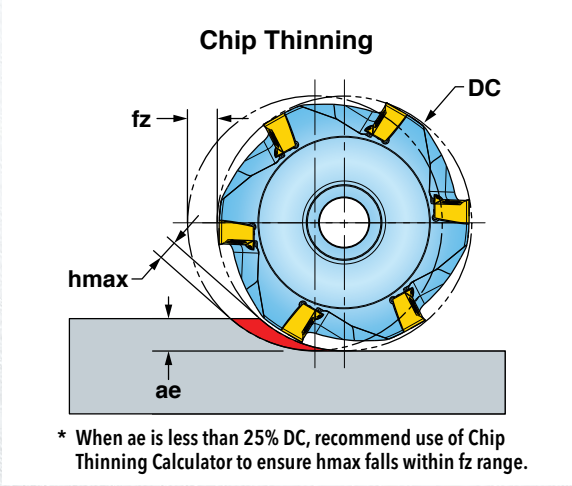

ISO	Materials			Vc Cutting Speed SFM	fz* Feed/Tooth (inch)	Harder.....Tougher						Coolant	
	Mat'l Group #VDI 3323	Type	Examples			IN2504	IN2540	IN10K	IN2510	IN2505	IN4030 IN2530		IN2035
P	1 thru 5	Non-alloy Steel	1018, A36, 1045, A572, 1070	400-1000	.003-.008		3			2	1	No	
	6 thru 9	Low-alloy Steel	4140, 4340, P20, 8620, 300M	350-700									
	10, 11	High-alloy Steel	H13, A2, D2, M2, T1	300-600									
M	12 thru 13	Stainless Steel (Fer- ritic & Martensitic)	410, 416, 440	350-600	.003-.006		3			2	1	Yes	
	14	Stainless Steel (Austenitic)	303, 304, 316, 15-5, 17-4	300-550									1
K	15 thru 16	Gray Cast Iron	CLS. 20, 30, 45	500-1000	.003-.008	2			1	3		No	
	17 thru 20	Nodular Cast Iron	60-40-18, 100-70-03	400-800									
N	21 - 30	Aluminum	7075, 6061		.003-.010			1				Yes	
S	31 thru 35	High-Temp Alloys	Inconel, Hastelloy, Nimonic, Monel	65-200	.003-.005					2	3	1	Yes
	36 thru 37	Titanium Alloys	6Al-4V, 5Al-5Mo-5V-3Cr	85-200						3	2	1	
H	38 thru 39	Hardened Steel >48	A2, O1, D2	130-250	.003-.005	1				2		No	

Note: Feed and speed recommendations are starting operating parameters. They are only guidelines from which further optimization should take place. Operating parameters are influenced by many machining variables. These variables may cause for reductions in feeds and speed or dramatic increases. Additionally, DOC and WOC may need to be revised to optimize the tools performance.



HIPOSTRIO™ 13 OPERATING GUIDELINES

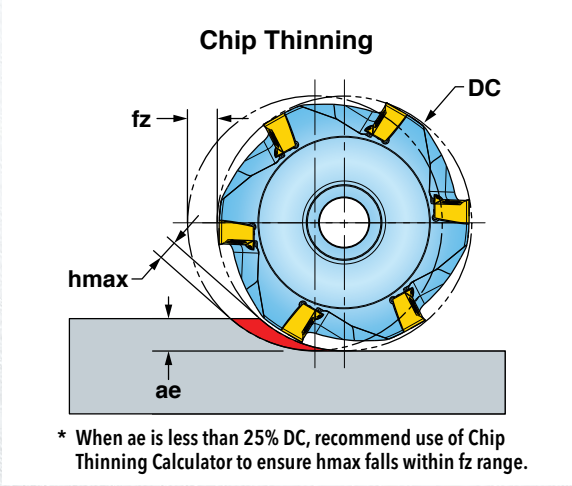

ISO	Materials			Vc Cutting Speed SFM	fz* Feed/Tooth (inch)	Harder.....Tougher						Coolant	
	Mat'l Group #VDI 3323	Type	Examples			IN2504	IN2540	IN10K	IN2510	IN2505	IN4030 IN2530		IN2035
P	1 thru 5	Non-alloy Steel	1018, A36, 1045, A572, 1070	400-1000	.003-.009								No
	6 thru 9	Low-alloy Steel	4140, 4340, P20, 8620, 300M	350-700		3			2	1			
	10, 11	High-alloy Steel	H13, A2, D2, M2, T1	300-600									
M	12 thru 13	Stainless Steel (Fer- ritic & Martensitic)	410, 416, 440	350-600	.003-.007		3		2	1		Yes	
	14	Stainless Steel (Austenitic)	303, 304, 316, 15-5, 17-4	300-550								1	
K	15 thru 16	Gray Cast Iron	CLS. 20, 30, 45	500-1000	.003-.010							No	
	17 thru 20	Nodular Cast Iron	60-40-18, 100-70-03	400-800		2		1	3				
N	21 - 30	Aluminum	7075, 6061		.003-.010			1				Yes	
S	31 thru 35	High-Temp Alloys	Inconel, Hastelloy, Nimonic, Monel	65-200	.003-.006					2	3	1	Yes
	36 thru 37	Titanium Alloys	6Al-4V, 5Al-5Mo-5V-3Cr	85-200						3	2	1	
H	38 thru 39	Hardened Steel >48	A2, O1, D2	130-250	.003-.005	1				2		No	

Note: Feed and speed recommendations are starting operating parameters. They are only guidelines from which further optimization should take place. Operating parameters are influenced by many machining variables. These variables may cause for reductions in feeds and speed or dramatic increases. Additionally, DOC and WOC may need to be revised to optimize the tools performance.



HIPOSTRIO™ 04 RAMP DATA USING SERIES THLS04

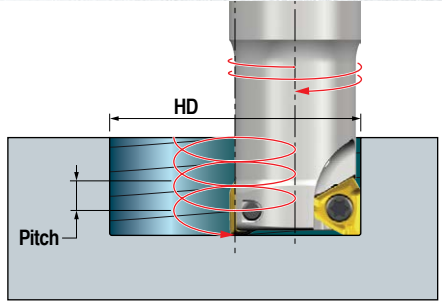
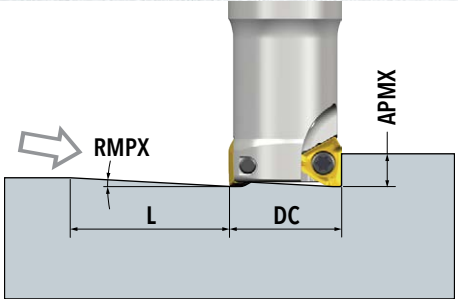

DC Cutter Diameter	Straight Ramp			Helical Ramp		
	RMPX Ramp Angle Max.	APMX Depth of Cut Max.	L Ramp Length Min.	HD Hole Diameter Min.	HD Hole Diameter Max.	Pitch Max.
0.312	2.1	0.13	3.6	0.52	0.62	.023
						.035
0.375	2.1	0.13	3.6	0.67	0.75	.031
						.047
0.437	3.6	0.13	2.2	0.75	0.87	.062
						.082
0.500	2.5	0.13	3.1	0.90	1.00	.055
						.066
0.562	2.1	0.13	3.6	0.99	1.12	.051
						.062
0.625	1.6	0.13	4.9	1.15	1.25	.043
						.055



HIPOSTRIO™ 06 RAMP DATA USING SERIES TH_S06

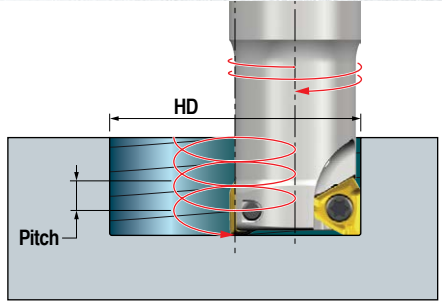
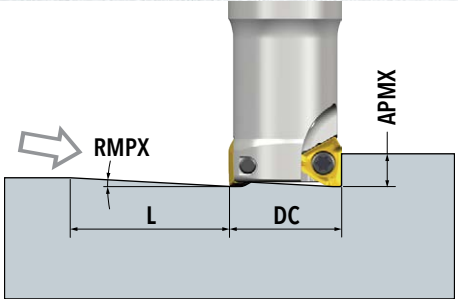

DC Cutter Diameter	Straight Ramp			Helical Ramp		
	RMPX Ramp Angle Max.	APMX Depth of Cut Max.	L Ramp Length Min.	HD Hole Diameter Min.	HD Hole Diameter Max.	Pitch Max.
0.625	4.0	0.27	3.8	0.94	1.25	0.080
						0.110
0.750	3.1	0.27	4.9	1.19	1.50	0.080
						0.130
0.875	2.5	0.27	6.1	0.56	1.75	0.090
						0.140
1.000	2.1	0.27	7.3	1.69	2.00	0.100
						0.120
1.250	1.5	0.27	10.3	2.19	2.50	0.090
						0.110
1.500	1.3	0.27	11.8	2.69	3.00	0.090
						0.110
2.000	1.2	0.27	12.8	3.69	4.00	0.100
						0.120
3.000	0.4	0.27	38.6	5.69	6.00	0.100
						0.110



HIPOSTRIO™ 10 RAMP DATA USING SERIES TH_S10

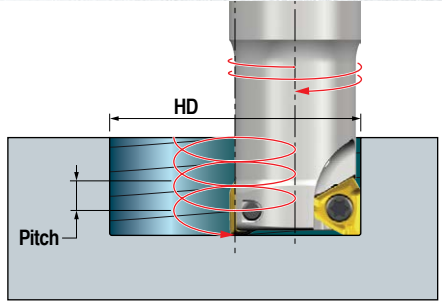
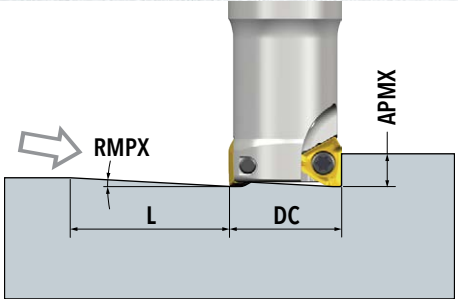

DC Cutter Diameter	Straight Ramp			Helical Ramp		
	RMPX Ramp Angle Max.	APMX Depth of Cut Max.	L Ramp Length Min.	HD Hole Diameter Min.	HD Hole Diameter Max.	Pitch Max.
1.250	2.7	0.41	8.6	2.04	2.50	0.120
						0.180
1.500	1.7	0.41	13.8	2.57	3.00	0.100
						0.130
2.000	1.2	0.41	19.5	3.58	4.00	0.100
						0.120
2.500	1.0	0.41	23.4	4.57	5.00	0.110
						0.120
3.000	0.7	0.41	33.5	5.57	6.00	0.110
						0.120
4.000	0.6	0.41	39.1	7.57	8.00	0.110
						0.120
5.000	0.4	0.41	58.7	9.57	10.00	0.110
						0.110



HIPOSTRIO™ 13 RAMP DATA USING SERIES TH_S13

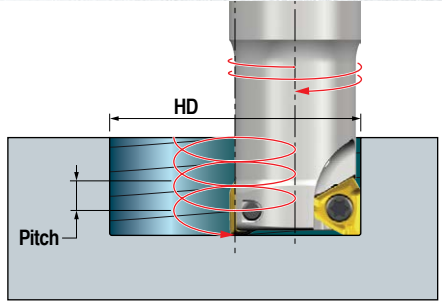
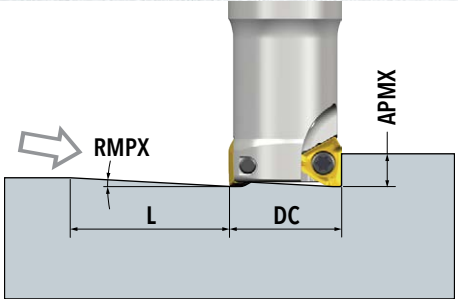

DC Cutter Diameter	Straight Ramp			Helical Ramp		
	RMPX Ramp Angle Max.	APMX Depth of Cut Max.	L Ramp Length Min.	HD Hole Diameter Min.	HD Hole Diameter Max.	Pitch Max.
2.000	1.5	0.57	21.7	3.49	4.00	0.140
						0.160
2.500	1.1	0.57	29.6	4.50	5.00	0.130
						0.140
3.000	0.8	0.57	40.8	5.51	6.00	0.130
						0.140
4.000	0.6	0.57	54.4	7.51	8.00	0.120
						0.140
5.000	0.5	0.57	65.3	9.53	10.00	0.120
						0.130
6.000	0.4	0.57	81.6	11.53	12.00	0.120
						0.130
6.500	0.2	0.57	163.0	12.53	13.00	0.120
						0.130