



# DEEPDOO™

DRILLING PRODUCTS

**Drilling Range:**

1.103"-1.575"  
(28.01mm - 40mm)

**Insert Grades:**

P: IN6542  
M: IN2005  
K: IN1510  
K, S: IN2510  
M, S: IN2004

**Chipbreakers:**

G Chipbreaker  
(For general use)  
B Chipbreaker  
(For High-Temp/Stainless)

**Guide Pads\*:**

IN2040  
IN2005  
IN2030

\* Guide Pads and Inserts must be purchased separately.



## Indexable Gundrill with exceptional efficiency now in LARGER DIAMETERS!

**DEEPDOOMC™** - Conventional style drill for lathes or mills,  
Conventional cross-hole style drill for lathes or mills  
Standard Lengths 10xD, 15xD and 25xD  
Dia. Range: 1.103" - 1.575" (28.01mm - 40mm)

**DEEPDOOCD™** - Gundrill style  
Gundrill cross-hole style  
Both styles offer lengths up to 94.488" OAL (2400mm)  
Dia. Range: 1.103" - 1.575" (28.01mm - 40mm)

**Features & Benefits:**

- Designed to provide maximum performance based on our experience in deep hole drilling
- NPHT/NPMT inserts with proven high performance in deep hole drilling
- Crimped steel tubing for effective chip evacuation and high tool body rigidity
- Specially designed edge prevents chip jamming
- Two guide pads have self guiding effect which provides excellent surface finish and superior hole straightness
- Large coolant holes supply excellent coolant flow and pressure





# DEEPDUOMC™ CONVENTIONAL DRILLS (INCH)



Drilling

Coolant

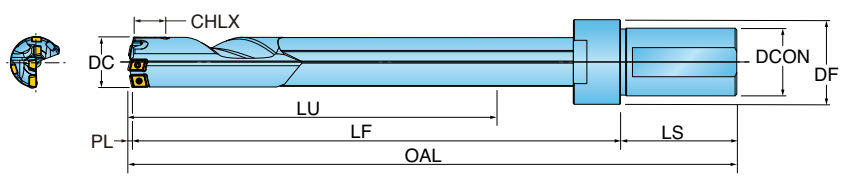

Part Number	DC Cutting Dia.	ULDR Usable Length to Dia. Ratio	PL Point Length	CHLX Cross-Hole Length Max.	LU Usable Length	LF Functional Length	LS Shank Length	OAL Overall Length	DF Flange Diameter	DCON Shank Dia.
GF28580285N6R01	1.125	10	0.102	0.629	11.52	14.17	2.72	16.99	1.57	1.25" single flat
GF29360285N6R01	1.156	10	0.102	0.629	11.56	14.21	2.72	16.93	1.57	1.25" single flat
GF31750317N6R01	1.250	10	0.118	0.629	12.72	15.55	2.72	18.39	1.57	1.25" single flat
GF34930349N6R01	1.375	10	0.122	0.629	13.90	16.85	2.72	19.69	1.57	1.25" single flat
GF38100381N6R01	1.500	10	0.134	0.629	15.49	18.66	2.72	21.51	1.57	1.25" single flat
GF28580428N6R01	1.125	15	0.102	0.629	17.23	19.88	2.72	22.70	1.57	1.25" single flat
GF29360429N6R01	1.156	15	0.102	0.629	17.34	19.99	2.72	22.70	1.57	1.25" single flat
GF31750476N6R01	1.250	15	0.118	0.629	19.02	21.85	2.72	24.68	1.57	1.25" single flat
GF34930524N6R01	1.375	15	0.122	0.629	20.79	23.74	2.72	26.58	1.57	1.25" single flat
GF38100572N6R01	1.500	15	0.134	0.629	23.17	26.34	2.72	29.19	1.57	1.25" single flat
GF28580715N6R01	1.125	25	0.102	0.629	28.65	31.30	2.72	34.12	1.57	1.25" single flat
GF29360715N6R01	1.156	25	0.102	0.629	28.90	31.55	2.72	34.27	1.57	1.25" single flat
GF31750806N6R01	1.250	25	0.118	0.629	31.61	34.45	2.72	37.28	1.57	1.25" single flat
GF34930873N6R01	1.375	25	0.122	0.629	34.57	37.52	2.72	40.36	1.57	1.25" single flat
GF38100953N6R01	1.500	25	0.134	0.629	38.52	41.69	2.72	44.54	1.57	1.25" single flat



# DEEPUOMC™ CONVENTIONAL DRILLS (METRIC)

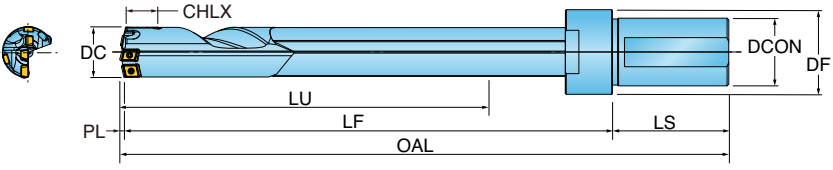

Part Number	DC Cutting Dia.	ULDR Usable Length to Dia. Ratio	PL Point Length	CHLX Cross-Hole Length Max.	LU Usable Length	LF Functional Length	LS Shank Length	OAL Overall Length	DF Flange Diameter	DCON Shank Dia.
GF3310275JHR01	33	8	3.0	16	275.0	350	69	422.0	50	40mm single flat
GF3910275JHR01	39	8	3.3	16	323.0	407	69	479.3	50	40mm single flat
GF29000292JHR01	29	10	2.6	16	292.6	360	69	431.6	50	40mm single flat
GF30000312JHR01	30	10	2.9	16	312.9	383	69	454.9	50	40mm single flat
GF31000312JHR01	31	10	2.9	16	323.0	383	69	454.9	50	40mm single flat
GF32000323JHR01	32	10	3.0	16	323.0	395	69	467.0	50	40mm single flat
GF33000333JHR01	33	10	3.1	16	333.1	406	69	478.1	50	40mm single flat
GF34000343JHR01	34	10	3.0	16	343.0	418	69	490.0	50	40mm single flat
GF35000353JHR01	35	10	3.1	16	353.1	428	69	500.1	50	40mm single flat
GF36000363JHR01	36	10	3.1	16	363.1	441	69	513.1	50	40mm single flat
GF37000373JHR01	37	10	3.0	16	373.0	451	69	523.0	50	40mm single flat
GF38000383JHR01	38	10	3.1	16	383.1	464	69	536.1	50	40mm single flat
GF39000393JHR01	39	10	3.4	16	393.4	474	69	546.4	50	40mm single flat
GF40000403JHR01	40	10	3.3	16	403.3	487	69	559.3	50	40mm single flat
GF29000437JHR01	29	15	2.6	16	437.6	505	69	576.60	50	40mm single flat
GF30000467JHR01	30	15	2.9	16	467.9	538	69	609.90	50	40mm single flat
GF31000467JHR01	31	15	2.9	16	467.9	538	69	609.90	50	40mm single flat
GF32000483JHR01	32	15	3.0	16	483.0	555	69	627.00	50	40mm single flat
GF33000498JHR01	33	15	3.1	16	498.1	571	69	643.10	50	40mm single flat
GF34000513JHR01	34	15	3.0	16	513.0	588	69	660.00	50	40mm single flat
GF35000528JHR01	35	15	3.1	16	528.1	603	69	675.10	50	40mm single flat
GF36000543JHR01	36	15	3.1	16	543.1	621	69	693.10	50	40mm single flat
GF37000558JHR01	37	15	3.0	16	558.0	636	69	708.00	50	40mm single flat
GF38000573JHR01	38	15	3.1	16	573.1	654	69	726.10	50	40mm single flat
GF39000588JHR01	39	15	3.4	16	588.4	669	69	741.40	50	40mm single flat
GF40000603JHR01	40	15	3.3	16	603.3	687	69	759.30	50	40mm single flat
GF30000778JHR01	30	25	2.9	16	777.9	848	69	919.90	50	40mm single flat



## DEEPDUO<sup>GD</sup>™ GUNDRILLS (INCH)

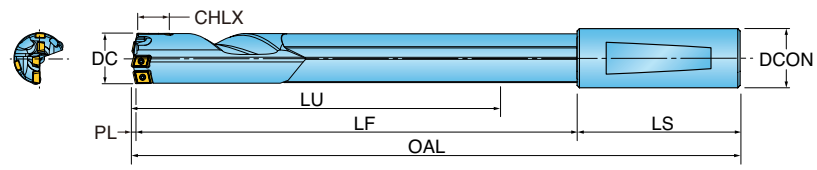

Part Number	DC Cutting Dia.	PL Point Length	CHLX Cross-Hole Length Max.	LU Usable Length	LF Functional Length	LS Shank Length	OAL Overall Length	DCON Shank Dia.
GF-2936-1828-N6-R01	1.156	0.102	0.629	66.52	69.35	2.72	72.01	1.25" w/notch
GF-3000-1650-N6-R01	1.181	0.114	0.629	59.48	63.97	2.72	65.07	1.25" w/notch

## DEEPDUO<sup>GD</sup>™ GUNDRILLS (METRIC)

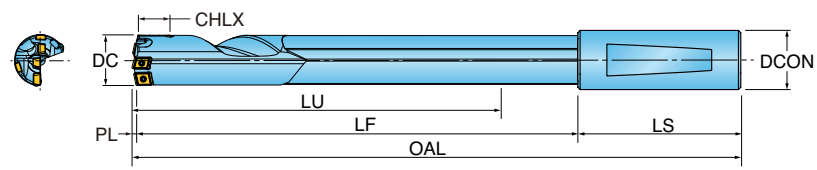

Part Number	DC Cutting Dia.	PL Point Length	CHLX Cross-Hole Length Max.	LU Usable Length	LF Functional Length	LS Shank Length	OAL Overall Length	DCON Shank Dia.
GF-3000-1000-JH-R01	30.000	2.900	16	860.90	974.9	69	1002.9	40mm notch
GF-3000-1650-JH-R01	30.000	2.900	16	1510.90	1624.9	69	1652.9	40mm notch

# DEEPDOO™ INSERT SIZE & GEOMETRY

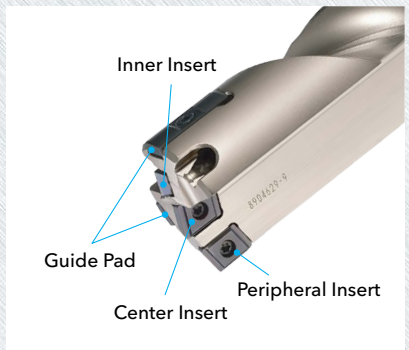

Chipbreaker	Part Number	Old Part Number	Dimensions (in)				Grade					
			W	INSL	S1	RE	IN6542	IN2004	IN2005	IN1510	IN2510	
G (General Use)	Center	NPMT060308L-G	NPMT05503L-G	0.217	0.315	0.118	0.031			X	X	
		NPMT070408L-G	NPMT06504L-G	0.256	0.394	0.157	0.031	X		X	X	X
		NPMT080408L-G	NPMT08004L-G	0.315	0.394	0.157	0.031	X		X	X	X
		NPMT100408L-G	NPMT09504L-G	0.374	0.394	0.157	0.031	X		X	X	X
		NPMT130408L-G	NPMT12504L-G	0.492	0.394	0.157	0.031	X		X	X	X
	Inner	NPMT060304R-G	NPMT05503R-G	0.217	0.315	0.118	0.016			X	X	
		NPMT070404R-G	NPMT06504R-G	0.256	0.394	0.157	0.016	X		X	X	X
		NPMT080404R-G	NPMT08004R-G	0.315	0.394	0.157	0.016	X		X	X	X
		NPMT100404R-G	NPMT09504R-G	0.374	0.394	0.157	0.016	X		X	X	X
		NPMT130404R-G	NPMT12504R-G	0.492	0.394	0.157	0.016	X		X	X	X
	Peripheral	NPHT060304R-G	NPHT06003R-G	0.236	0.315	0.118	0.016			X	X	
		NPHT080404R-G	NPHT07504R-G	0.295	0.394	0.157	0.016			X	X	
		NPHT090404R-G	NPHT09004R-G	0.354	0.394	0.157	0.016			X	X	
		NPHT110404R-G	NPHT11004R-G	0.433	0.394	0.157	0.016			X	X	
		NPHT130404R-G	NPHT13004R-G	0.512	0.394	0.157	0.016			X	X	
B (High-Temp/ Stainless)	Center	NPMT060308L-B		0.217	0.315	0.118	0.031		X	X		
		NPMT070408L-B		0.256	0.394	0.157	0.031		X	X		
		NPMT080408L-B		0.315	0.394	0.157	0.031		X	X		
		NPMT100408L-B		0.374	0.394	0.157	0.031		X	X		
		NPMT130408L-B		0.492	0.394	0.157	0.031		X	X		
	Inner	NPMT060304R-B		0.217	0.315	0.118	0.016		X	X		
		NPMT070404R-B		0.256	0.394	0.157	0.016		X	X		
		NPMT080404R-B		0.315	0.394	0.157	0.016		X	X		
		NPMT100404R-B		0.374	0.394	0.157	0.016		X	X		
		NPMT130404R-B		0.492	0.394	0.157	0.016		X	X		
	Peripheral	NPHT060308R-B		0.236	0.315	0.118	0.031		X	X		
		NPHT080408R-B		0.295	0.394	0.157	0.031		X	X		
		NPHT090408R-B		0.354	0.394	0.157	0.031		X	X		
		NPHT110408R-B		0.433	0.394	0.157	0.031		X	X		
		NPHT130408R-B		0.512	0.394	0.157	0.031		X	X		

Ordering Example: NPHT060304R-G IN2005 10pcs

• Standard stock item



**DEEPPDUO™ INSERT SELECTION**

DC	Insert			Maximum Difference PL
	Peripheral	Inner	Center	
1.103 - 1.142	NPHT060304R	NPMT060304	NPMT070408L	0.102
1.143 - 1.181	NPHT060304R	NPMT060304	NPMT070408L	0.102
1.182 - 1.220	NPHT080404R	NPMT070404R	NPMT070408L	0.114
1.221 - 1.260	NPHT080404R	NPMT070404R	NPMT070408L	0.118
1.261 - 1.299	NPHT080404R	NPMT070404R	NPMT070408L	0.122
1.300 - 1.339	NPHT080404R	NPMT070404R	NPMT070408L	0.118
1.340 - 1.378	NPHT080404R	NPMT070404R	NPMT070408L	0.122
1.378 - 1.417	NPHT080404R	NPMT070404R	NPMT080408L	0.122
1.418 - 1.457	NPHT080404R	NPMT070404R	NPMT080408L	0.118
1.458 - 1.496	NPHT080404R	NPMT070404R	NPMT080408L	0.122
1.497 - 1.535	NPHT090404R	NPMT070404R	NPMT080408L	0.134
1.536 - 1.575	NPHT090404R	NPMT070404R	NPMT080408L	0.130

**DEEPPDUO™ HARDWARE**

Part Description		Drill Diameter				
		1.103 - 1.181	1.182 - 1.299	1.300 - 1.378	1.379 - 1.496	1.497 - 1.575
Inserts	Outer	NPHT060304R	NPHT080404R	NPHT080404R	NPHT080404R	NPHT090404R
	Insert Screw	CSTB2.2	CSTB2.5	CSTB2.5	CSTB2.5	CSTB2.5
	Wrench	T-7F	T-8F	T-8F	T-8F	T-8F
	Inner	NPMT060304R	NPMT070404R	NPMT070404R	NPMT070404R	NPMT070404R
	Insert Screw	CSTB2.2	CSTB2.5	CSTB2.5	CSTB2.5	CSTB2.5
	Wrench	T-7F	T-8F	T-8F	T-8F	T-8F
	Center	NPMT070408L	NPMT070408L	NPMT070408L	NPMT080408L	NPMT080408L
	Insert Screw	CSTB2.5	CSTB2.5	CSTB2.5	CSTB2.5	CSTB2.5
	Wrench	T-8F	T-8F	T-8F	T-8F	T-8F
Pads	Guide Pad	PAD-GP06-020-120	PAD-GP06-020-120	PAD-GP07-020-120	PAD-GP07-020-120	PAD-GP08-025-155
	Screw	SR34-508	SR34-508	SR34-508	SR34-508	SR34-508
	Wrench	T-7F	T-7F	T-7F	T-7F	T-7F



# DEEPDUO™ GUIDE PADS

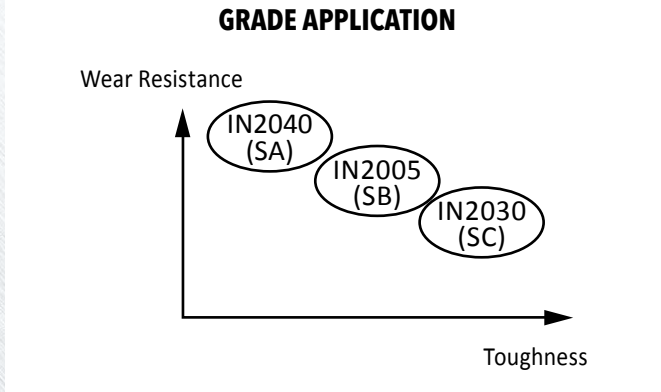
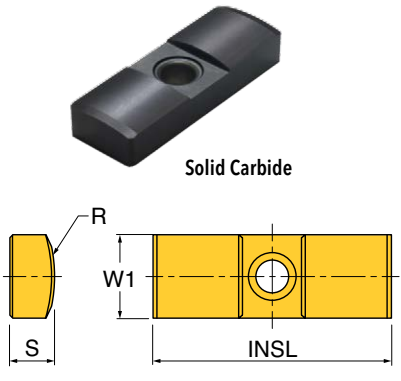

**NEW**  
**NEW**

**NEW**  
**NEW**

**NEW**  
**NEW**

**NEW**  
**NEW**

**NEW**  
**NEW**

New Part Number	Old Part Number	W Width	S Thickness	INSL Length	R Radius	Screw
PAD-GP06-020-120 IN2040	PAD-GO06CD-SA	0.236	0.118	0.787	0.472	CSTB2.25
PAD-GP06-020-120 IN2005	PAD-GO06CD-SB					
PAD-GP06-020-120-DC IN2005	-					
PAD-GP06-020-120-DC IN2030	PAD-GO06CD-SC	0.276	0.138	0.787	0.472	CSTB35
PAD-GP07-020-120 IN2040	PAD-GO07CD-SA					
PAD-GP07-020-120 IN2005	PAD-GO07CD-SB					
PAD-GP07-020-120-DC IN2005	-	0.315	0.177	0.984	0.610	CSTB35
PAD-GP08-025-155 IN2040	PAD-GO08CD-SA					
PAD-GP08-025-155 IN2005	PAD-GO08CD-SB					
PAD-GP08-025-155-DC IN2005	-	0.394	0.177	1.181	0.787	CSTB3.5
PAD-GP08-025-155-DC IN2030	PAD-GO08CD-SC					
PAD-GP10-030-200 IN2040	PAD-GO10CD-SA					
PAD-GP10-030-200 IN2005	PAD-GO10CD-SB	0.472	0.216	1.378	0.984	CSTB3.5
PAD-GP10-030-200-DC IN2005	-					
PAD-GP10-030-200-DC IN2030	PAD-GO10CD-SC					
PAD-GP12-035-250 IN2040	PAD-GO12CD-SA	0.472	0.216	1.378	0.984	CSTB3.5
PAD-GP12-035-250 IN2005	PAD-GO12CD-SB					
PAD-GP12-035-250-DC IN2005	-					
PAD-GP12-035-250-DC IN2030	PAD-GO12CD-SC					

Ordering Example: PAD-GP08-025-155 5pcs

# DEEPDUO™ DIAMETER ADJUSTING SHIMS

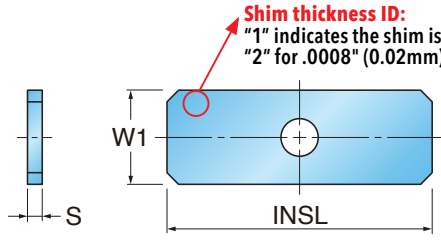

**Shim thickness ID:**  
 "1" indicates the shim is .0004" (0.01mm) thick,  
 "2" for .0008" (0.02mm), "3" for .0012" (0.03mm)...

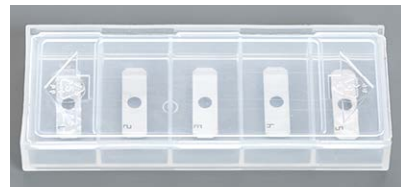

0.01mm / 0.02mm / 0.03mm / 0.04mm / 0.05mm  
 .0004" / .0008" / .0012" / .0016" / .0020"

Part Number	W1 Width inch (mm)	INSL Length inch (mm)	S Thickness inch (mm)	Application Guide Pad Size
SHIMSET-GP04	.157 (4)	.626 (15.9)	.0004 - .0020 (0.01 - 0.05)	PAD-G004
SHIMSET-GP05	.197 (5)	.709 (18)	.0004 - .0020 (0.01 - 0.05)	PAD-G005
SHIMSET-GP06	.236 (6)	.787 (20)	.0004 - .0020 (0.01 - 0.05)	PAD-G006

- A shim set contains 5 shims in thicknesses of .0004" (0.01mm), .0008" (0.02mm), .0012" (0.03mm), .0016" (0.04mm) and .0020" (0.05mm), respectively.
- **Adjusting shims are sold by set only, not to be sold separately.**

Diameter Adjustments inch (mm)	Shim(s) for measuring guide pad inch (mm)	Shim(s) for supporting guide pad inch (mm)	Number of shim sets needed
+ .0004 (+0.01)	.0004 (0.01)	-	1
+ .0008 (+0.02)	.0008 (0.02)	.0004 (0.01)	1
+ .0012 (+0.03)	.0012 (0.03)	.0004 + .0008 (0.01 + 0.02)	1
+ .0016 (+0.04)	.0016 (0.04)	.0004 + .0012 (0.01 + 0.03)	1
+ .0020 (+0.05)	.0020 (0.05)	.0008 + .0012 (0.02 + 0.03)	1
+ .0024 (+0.06)	.0004 + .0020 (0.01 + 0.05)	.0008 + .0016 (0.02 + 0.04)	1
+ .0028 (+0.07)	.0008 + .0020 (0.02 + 0.05)	.0012 + .0016 (0.03 + 0.04)	1
+ .0031 (+0.08)	.0012 + .0020 (0.03 + 0.05)	.0016 + .0016 (0.04 + 0.04)	2
+ .0035 (+0.09)	.0016 + .0020 (0.04 + 0.05)	.0016 + .0020 (0.04 + 0.05)	2
+ .0039 (+0.10)	.0020 + .0020 (0.05 + 0.05)	.0016 + .0016 + .0008 (0.04 + 0.04 + 0.02)	2

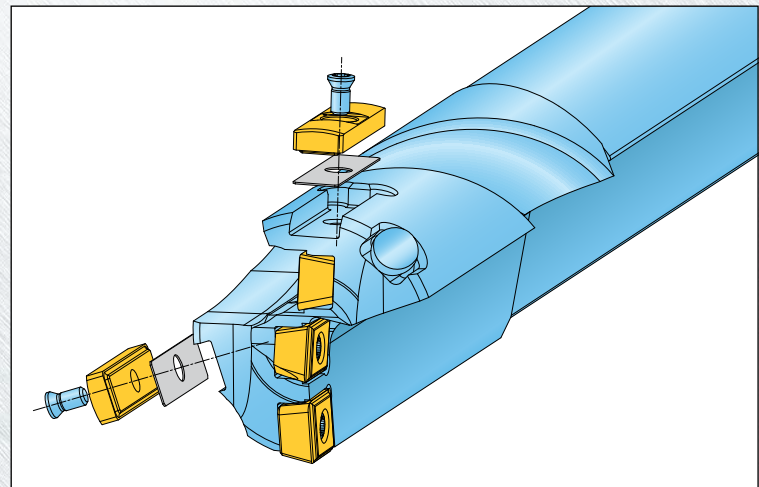



**DEEPPDUO™ HOW TO INSTALL ADJUSTING SHIMS**

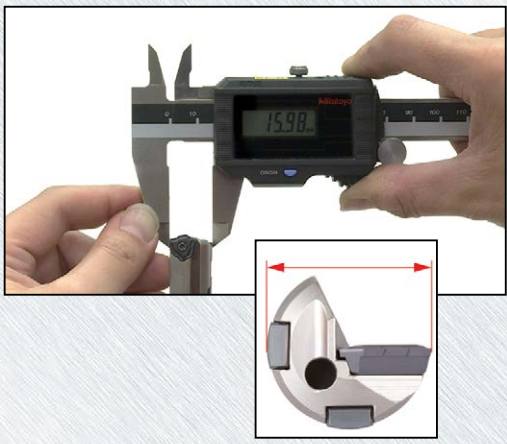

**STEP 1:**  
Measure the Deep•Duo drill diameter between the measuring guide pad and the insert cutting edge. If a presetter is not available, use a micrometer or caliper. For a precise drill diameter measurement, it is recommended to test-drill a hole and measure the hole diameter.

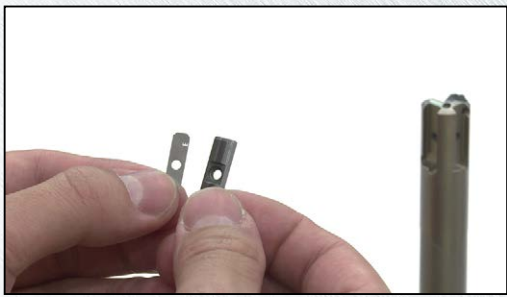

**STEP 2:**  
Select the shim combinations according to the chart on Page 10 to obtain the required hole diameter. Take into consideration that the actual diameter of the drilled hole tends to be slightly larger (usually +.0008" to +.0012") than the drill's nominal diameter – i.e. add .0008"-.0012" to the measured drill diameter in Step 1 above before the final drill diameter.



**STEP 3:**  
Remove the guide pads.



**STEP 5:**  
Measure the drill diameter again to confirm the required diameter is obtained on the Deep•Duo.

**STEP 6:**  
Test drill a hole to confirm that the required hole diameter is achieved.



## DEEPDUO™ TRH HEAD

Now Available! The TRH brazed head of the DeepDuo tools are now available as a separate item which allows customers to repair their Deep Trio tools by brazing a new head onto the body after removing the old one.

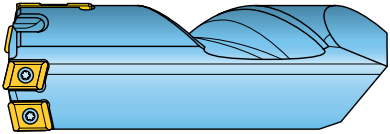
	Type	Tool Dia(mm)	Tool Dia(in)	Part Number
	3 Insert Type	29.00	1.142	TRH-29.00-FB MKT
		30.00	1.181	TRH-30.00-FB MKT
		31.00	1.220	TRH-31.00-FB MKT
		32.00	1.260	TRH-32.00-FB MKT
		33.00	1.299	TRH-33.00-FB MKT
		34.00	1.339	TRH-34.00-FB MKT
		35.00	1.378	TRH-35.00-FB MKT
		36.00	1.417	TRH-36.00-FB MKT

## DEEPDUO™ RECOMMENDED MACHINING PROCESS

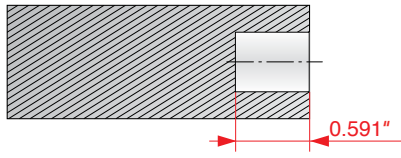

1. Pilot Hole  
Drill Diameter +0.0039" ~ +0.0012"  
Depth = 0.591"

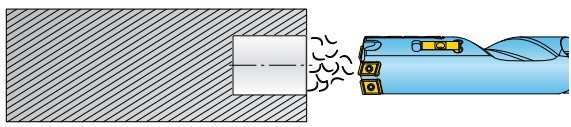

2. Approach - Rapid, Coolant On  
Vc = 16 ~ 32 SFM  
f = 0.02" ~ 0.039"/rev  
Depth = 0.394"

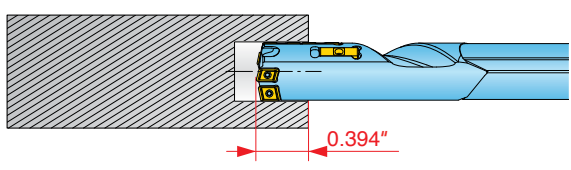

3. Enter Pilot Hole, Begin Drilling  
0.394" ~ 0.984"  
Vc: 100 %  
f: 80 %

4. Drill Feed After 1.00"  
Vc: 100 %  
f: 100 %

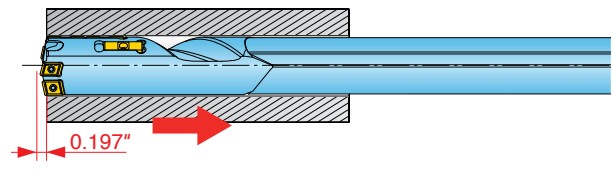

5. Retract. Stop rotation and coolant before moving the drill back to starting position.

## DEEPDUO™ DRILLING PROCESS (CROSS-HOLES)

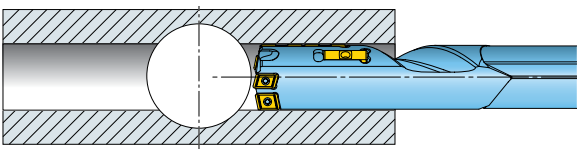

1. .04" - .08" before cross-hole  
Reduce feed by 30 - 50%  
Maintain same RPM

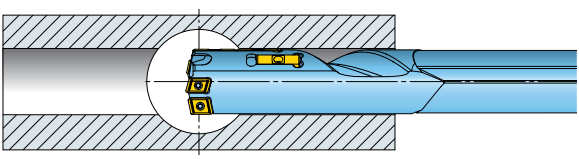

2. Cross through hole  
Maintain same RPM

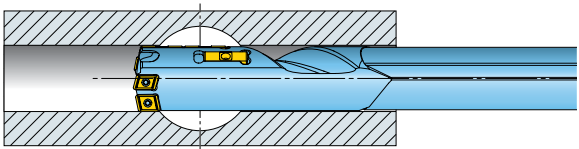

3. .04" - .08" after cross-hole.  
Resume original feed rate and RPM

**\*NOTE:**  
**Possible risks:** To prevent injuries, do NOT operate any deep hole drill, which uses pre-drilled pilot hole, at full speed before entering the pilot hole. The deep hole drill may fracture due to vibration and cause injuries.  
**Counter measures:** Do NOT operate the deep hole drill at full speed before engaging the pilot hole. Enter the pilot hole slowly at a speed of 50 - 100 RPM.



## **INSERT GRADES**

- IN2005 PVD coating. Good for most materials
- IN6542 CVD coating. Good for steel and cast steel
- IN1510 Tough PVD coating. Good for stainless steel, steel, cast steel and cast iron
- IN2510 PVD coating. Good for stainless steel and cast iron
- IN2004 PVD coating. Good for stainless steel and high-temp alloys

## **INSERT CHIPBREAKERS**

- NPMT\_\_\_RG First recommendation for peripheral and inner insert. Good for most materials
- NPMT\_\_\_LG First recommendation for center insert. Good for all materials
- NPMT\_\_\_DT Positive design for peripheral and inner insert. Good for lowering cutting resistance.



## DEEPUO™ APPLICATION NOTES

Be sure to drill a pilot hole before using Deep Duo!

Stack drilling is NOT recommended!

Interrupted cut can be done in some cases. Please contact your Ingersoll Sales Engineer.

Supply coolant with enough pressure and volume

For example: 218 PSI for 1.181" diameter, drilling depth 11.811"

Be careful of coolant leakage from adaptor. If leakage occurs at side lock screw, seal it with sealing tape.

Hole precision and finish

Precision for hole diameter is IT11. Surface Finish in 3 um.

Guide pad is a consumable item

The guide pad has 2 sides. When the wear comes to the 2nd side, rotate the guide pad.

When the 2nd side gets worn, replace the guide pad with a new one.

Using water-soluble coolant

The concentration of water soluble coolant is recommended to be around 10% (dilution rate 1/10) or more in order to protect the guide pads.

Selecting Cutting Conditions

Select and set speed and feed at the lowest value of the recommendations when drilling for the first time.

Then test at higher conditions watching the actual drilling situation

Chips may become too long which cause chip jamming with machine or work piece for some work materials

Chips are cut in curled shape and every chip looks like each other under a proper cutting condition.

Cutting conditions must be set not to exceed machine power

Cutting Condition - Example

Diameter	1.181"
Speed	328 SFM
Feed	.0039"
Material	AISI 1045
Power	6.798 HP



## DEEPDUO™ OPERATING GUIDELINES

Materials				Vc Cutting Speed SFM	Feed (inch/rev)	
ISO	Mat'l Group #VDI 3323	Type	Examples		G Chipbreaker	B Chipbreaker
<b>P</b>	1-5	Low carbon steels (C <0.3)	1018, A36, 1045, A572, 1070	262 - 394	.0035 - .008	.001 - .004
	6-9	Carbon steels (C >0.3)	4140, 4340, P20, 8620, 300M			
	10-11	Low alloy steels	H13, A2, D2, M2, T1			
	ISO	Alloy steels				
<b>M</b>	12-13	Stainless steels (Austenitic)	410, 416, 440	197 - 328	.0035 - .006	.001 - .004
	14	Stainless steels (Martensitic and ferritic)	303, 304, 316, 15-5, 17-4			
		Stainless steels (Precipitation hardening)				
<b>K</b>	15-20	Ductile cast iron	CLS. 20, 30, 45	197 - 459	.0035 - .012	.001 - .0055
	17-18	Gray cast iron	60-40-18, 100-70-03			
<b>N</b>	21-24	Aluminum Alloy	7075, 6061	328 - 656	.0035 - .010	.001 - .008
<b>S</b>	31-35	High-Temp Alloys	Inconel, Hastelloy, Nimonic, Monel	66 - 164	.002 - .007	.001 - .004
	36-37	Titanium Alloys	Ti-6Al-4V, 6Al-4V, 5Al-5Mo-5V-3Cr	98 - 197		
<b>H</b>	38-41	Hardened Steel >40	A2, O1, D2	131 - 328	.002 - .005	.001 - .004

Note: Feed and speed recommendations are starting operating parameters. They are only guidelines from which further optimization should take place. Operating parameters are influenced by many machining variables. These variables may cause for reductions in feeds and speed or dramatic increases.