



DIPOSTRIO™

MILLING PRODUCTS



Cutter Series (Applications)

- 1WJ / WJ
(Rough, Ramp, Drill-Mill)
- FHU
(Flat Bottom Plunge Mill)
- 1DJ_F / DJ_F
(Rough & Finish Mill)
- 1DJ_P / DJ_P
(Rough & Finish Mill)

Diameter Range

.750-6.00

Corner Radii

.015, .020, .031 & .062 R

Materials

Iron, Steel, Stainless Steel,
Aluminum, Hi-Temps
Titanium & Hard Steel

Trigon shape inserts offer 6-Edge-Economy; Oriented for multiple applications.

Features & Benefits:

- Plunge Mills that generate a flat bottom; ideal for light duty machines, deep reaches and relieving corners in a pocket
- Mills for roughing and aggressive ramping; produce 63-125 Ra surface finishes
- Mills with integrated wipers for roughing and finishing; produce 20-32 Ra surface finishes
- Dovetail pocket designs for secure clamping; thick inserts for utmost durability
- Inserts with multiple corner radii; grades for ferrous and non-ferrous materials
- Cutters ported with coolant through



DIPOSTRIO™ 04 SERIES FHU (CYLINDRICAL SHANK)

FLAT BOTTOM PLUNGE ROUGH MILL (4MM INSERT)

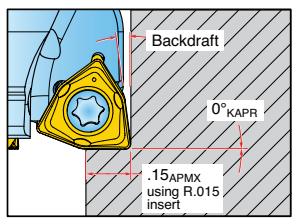
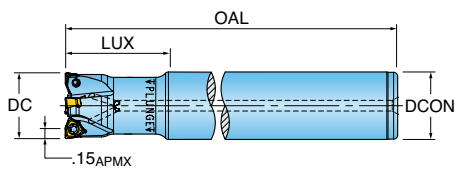

Part Number	DC Cutting Dia.	LUX Usable Length Max.	OAL Overall Length	ZEFF Effective Teeth	DCON Shank Dia.
FHU-07030S7R01	0.750	1.50	5.00	3	0.750
FHU-10032S1R01	1.000	1.50	5.50	4	1.000

Note: Cutter body can be modified; shorten by cutting off back end or add usable length by turning back neck diameter.

DIPOSTRIO™ 04 SERIES FHU (TOP-ON STYLE)

FLAT BOTTOM PLUNGE ROUGH MILL (4MM INSERT)

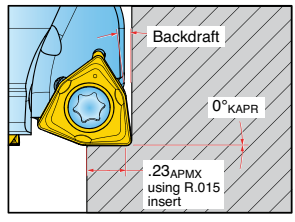
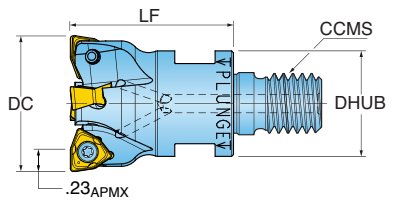

Part Number	DC Cutting Dia.	LF Functional Length	ZEFF Effective Teeth	CCMS Connection Code Machine Side	DHUB Hub Dia.
FHU-07012X6R01	0.750	1.25	3	TopOn M10	0.69
FHU-10015X7R01	1.000	1.50	4	TopOn M12	0.81



DIPOSTRIO™ 04 INSERTS

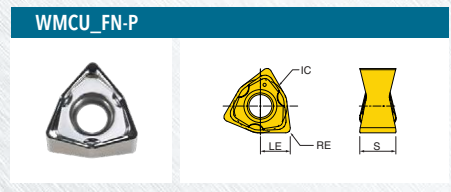
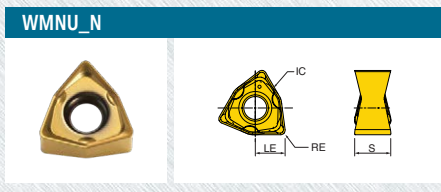
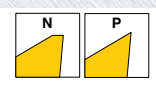

Part Number	Application	RE/BCH Corner Radius/ Chamfer	LE Cutting Edge Length	IC Inscribed Circle Dia.	S Thickness (To Cutting Edge)	NOI Number of Indexes	IH Insert Hand	Grade	IN10K	IN6535	IN2035	IN2504	IN2505	IN2530	IN4030
WNMU04T304N	Multi-Purpose	0.015 R	0.150	0.248	0.157	6	Neutral			•	•	•	•	•	•
WNCU04T304FN-P	Non-Ferrous	0.015 R	0.150	0.248	0.157	6	Neutral	•							

DIPOSTRIO™ 04 HARDWARE

	Insert Screw	Driver	Wrench	**OPTIONAL** Torque Driver Handle	**OPTIONAL** Preset Torque Bit	**OPTIONAL** Torque Driver Bit	
FHU-07012X6R01	SM25-064-00	DS-T08W	615MM	DS-A00-.25-S	DT-11-.25	DS-T08B	
FHU-07030S7R01	SM25-064-00	DS-T08W	-	DS-A00-.25-S	DT-11-.25	DS-T08B	
FHU-10015X7R01	SM25-064-00	DS-T08W	617MM	DS-A00-.25-S	DT-11-.25	DS-T08B	
FHU-10032S1R01	SM25-064-00	DS-T08W	-	DS-A00-.25-S	DT-11-.25	DS-T08B	

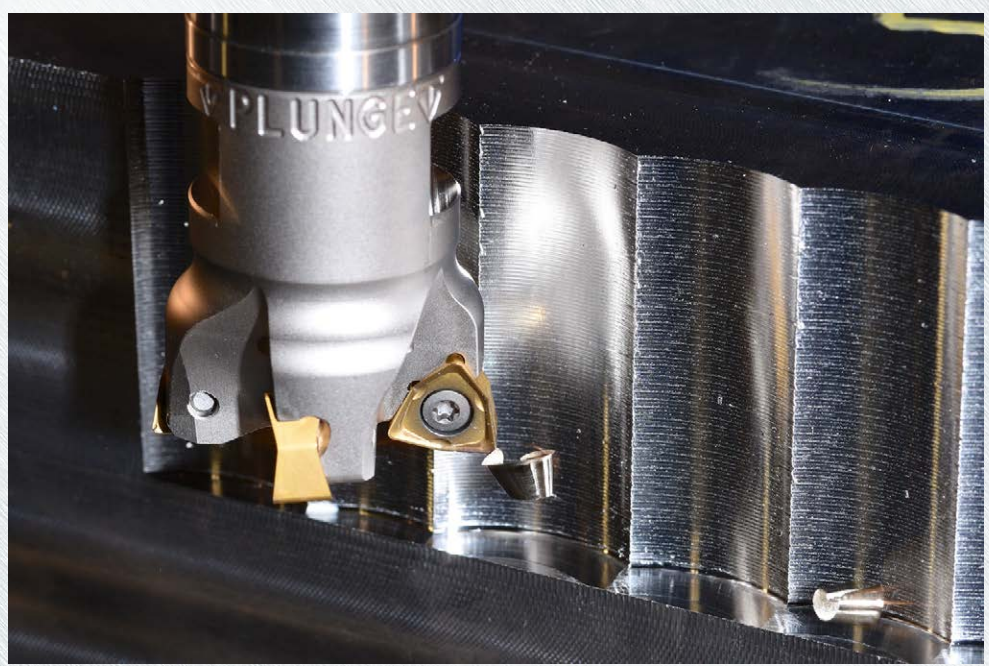



DIPOSTRIO™ 06 SERIES FHU (CYLINDRICAL SHANK)

FLAT BOTTOM PLUNGE ROUGH MILL (6MM INSERT)

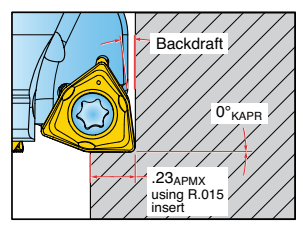
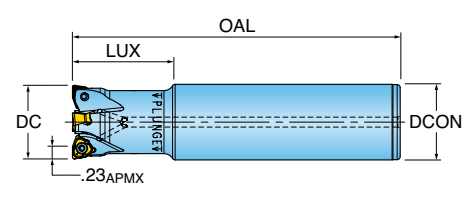

Part Number	DC Cutting Dia.	LUX Usable Length Max.	OAL Overall Length	ZEFF Effective Teeth	DCON Shank Dia.
FHU-1203759R01	1.250	2.00	6.00	3	1.250
FHU-1503855R01	1.500	2.00	6.50	4	1.500

Note: Cutter body can be modified; shorten by cutting off back end or add usable length by turning back neck diameter.

DIPOSTRIO™ 06 SERIES FHU (TOP-ON STYLE)

FLAT BOTTOM PLUNGE ROUGH MILL (6MM INSERT)

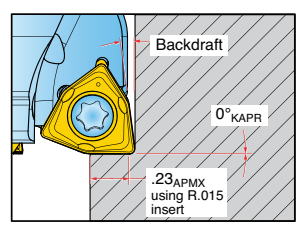
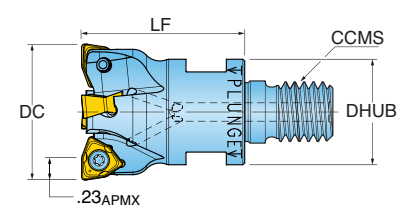

Part Number	DC Cutting Dia.	LF Functional Length	ZEFF Effective Teeth	CCMS Connection Code Machine Side	DHUB Hub Dia.
FHU-12017X8R01	1.250	1.75	3	TopOn M16	1.13
FHU-15017X8R01	1.500	1.75	4	TopOn M16	1.13



DIPOSTRIO™ 06 SERIES 1WJ1F (WELDON SHANK)

90° ROUGH & RAMP END MILL (6MM INSERT)

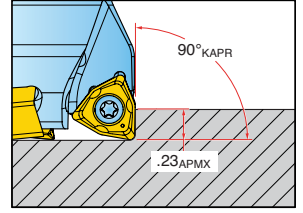
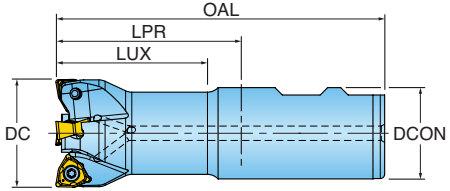

Part Number	DC Cutting Dia.	LUX Usable Length Max.	LPR Protruding Length	OAL Overall Length	ZEFF Effective Teeth	DCON Shank Dia.	RMPX Ramp Angle Max.
1WJ1F-1001780R01	1.000	1.72	1.75	4.00	2	1.000	2.7
1WJ1F-1202281R01	1.250	2.22	2.25	4.50	3	1.250	2
1WJ1F-1502281R01	1.500	2.22	2.25	4.50	4	1.250	1.6

DIPOSTRIO™ 06 SERIES WJ5F

90° ROUGH & RAMP FACE MILL (6MM INSERT)

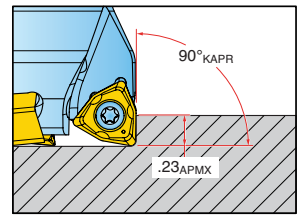
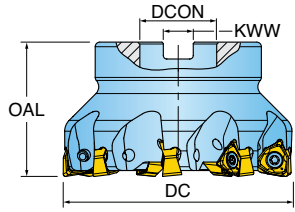

Part Number	DC Cutting Dia.	OAL Overall Length	ZEFF Effective Teeth	DCON Shank Dia.	KWW Keyway	RMPX Ramp Angle Max.
WJ5F-20R01	2.000	1.57	6	0.750	0.312	1.4
WJ5F-25R01	2.500	1.57	7	0.750	0.312	1.8
WJ5F-30R01	3.000	1.75	9	1.000	0.375	2.1
WJ5F-40R01	4.000	2.38	11	1.500	0.625	2.2



DIPOSTRIO™ 06 INSERTS

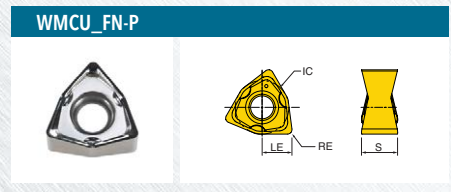
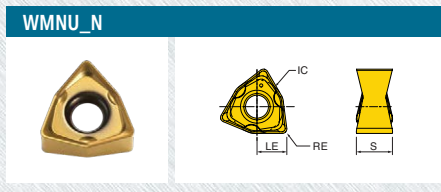
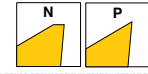

Part Number	Application	RE/BCH Corner Radius/ Chamfer	LE Cutting Edge Length	IC Inscribed Circle Dia.	S Thickness (To Cutting Edge)	NOI Number of Indexes	IH Insert Hand	Grade	IN10K	IN6535	IN2035	IN2504	IN2505	IN2530
WNMU060604N	Multi-Purpose	0.015 R	0.230	0.370	0.254	6	Neutral			•	•	•	•	
WNMU060608N	Multi-Purpose	0.031 R	0.230	0.370	0.244	6	Neutral			•	•	•	•	•
WNCU060608FN-P	Non-Ferrous	0.031 R	0.230	0.370	0.249	6	Neutral	•						

DIPOSTRIO™ 06 HARDWARE

	Insert Screw	Driver Handle	Driver Blade	Retention Bolt	Coolant Bolt	Torque Driver Handle	Preset Torque Bit	Torque Driver Bit
1WJ1F	SM35-088-60	DS-A00T	DS-T106B	-	-	DS-A00-.25-T	DT-30-.25	DS-T10B1
WJ5F-20R01	SM35-088-60	DS-A00T	DS-T106B	SD-06-46	SD-06-89	DS-A00-.25-T	DT-30-.25	DS-T10B1
WJ5F-25R01	SM35-088-60	DS-A00T	DS-T106B	SD-06-46	SD-06-89	DS-A00-.25-T	DT-30-.25	DS-T10B1
WJ5F-30R01	SM35-088-60	DS-A00T	DS-T106B	SD-08-46	SD-08-92	DS-A00-.25-T	DT-30-.25	DS-T10B1
WJ5F-40R01	SM35-088-60	DS-A00T	DS-T106B	SD-12-82	SD-12-99	DS-A00-.25-T	DT-30-.25	DS-T10B1



DIPOSTRIO™ 09 SERIES 1DJ1F (WELDON SHANK)

90° ROUGH & FINISH END MILL (9MM INSERT)

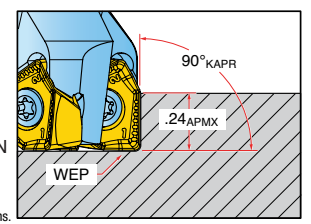
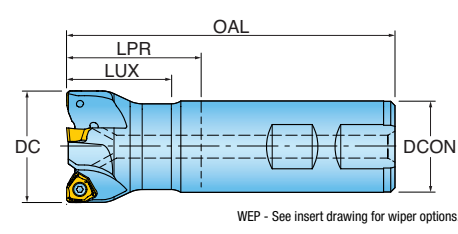

WEP - See insert drawing for wiper options.

Part Number	DC Cutting Dia.	LUX Usable Length Max.	LPR Protruding Length	OAL Overall Length	ZEFF Effective Teeth	DCON Shank Dia.
1DJ1F-1001584R01	1.000	1.50	1.50	3.50	2	0.750
1DJ1F-1001780R01	1.000	1.70	1.75	4.00	2	1.000
1DJ1F-1003780R01	1.000	3.70	3.75	6.00	2	1.000
1DJ1F-1201584R01	1.250	1.50	1.50	3.50	3	0.750
1DJ1F-1202281R01	1.250	2.20	2.25	4.50	3	1.250
1DJ1F-1204281R01	1.250	4.20	4.25	6.50	3	1.250
1DJ1F-1502281R01	1.500	2.20	2.25	4.50	4	1.250

DIPOSTRIO™ 09 SERIES 1DJ1F (TOP-ON STYLE)

90° ROUGH & FINISH END MILL (9MM INSERT)

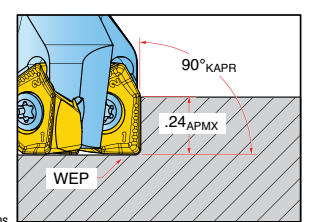
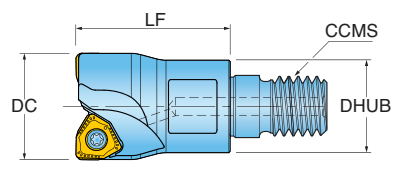

WEP - See insert drawing for wiper options.

Part Number	DC Cutting Dia.	LF Functional Length	ZEFF Effective Teeth	CCMS Connection Code Machine Side
1DJ1F-12017X8R01	1.250	1.75	3	TopOn M16



DIPOSTRIO™ 09 SERIES DJ5F, DJ6F

90° ROUGH & FINISH FACE MILL (9MM INSERT)

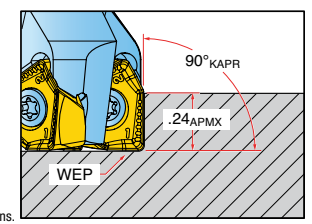
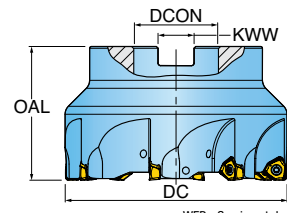

WEP - See insert drawing for wiper options.

Part Number	DC Cutting Dia.	OAL Overall Length	ZEFF Effective Teeth	DCON Shank Dia.	KWW Keyway
DJ5F-20R01	2.000	1.57	5	0.750	0.312
DJ5F-20R02	2.000	1.57	6	0.750	0.312
DJ5F-25R01	2.500	1.57	6	0.750	0.312
DJ5F-30R01	3.000	1.75	7	1.000	0.375
DJ5F-30R02	3.000	1.75	9	1.000	0.375
DJ5F-40R01	4.000	2.38	11	1.500	0.625
DJ6F-40R01	4.000	2.38	8	1.500	0.625



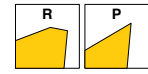



DIPOSTRIO™ 09 INSERTS



Part Number	Application	RE/BCH Corner Radius/ Chamfer	BS Wiper Length	LE Cutting Edge Length	IC Inscribed Circle Dia.	S Thickness (To Cutting Edge)	NOI Number of Indexes	IH Insert Hand	Grade	IN2505	IN2510	IN2530	IN2540	IN10K
WNGU090404R	Multi-Purpose	0.015 R	0.093	0.240	0.365	0.187	6	Right		•				
WNGU090405R	Multi-Purpose	0.020 R	0.093	0.240	0.365	0.187	6	Right		•				
WNGU090408R	Multi-Purpose	0.031 R	0.077	0.240	0.365	0.187	6	Right		•	•	•	•	
WNGU090416R	Multi-Purpose	0.062 R	0.046	0.240	0.365	0.187	6	Right		•	•	•		
WNGU090404FR-P	Non-Ferrous	0.015 R	0.093	0.240	0.365	0.187	6	Right						•
WNGU090408FR-P	Non-Ferrous	0.031 R	0.077	0.240	0.365	0.187	6	Right						•



DIPOSTRIO™ 09 HARDWARE

							
	Insert Screw	Driver	Retention Bolt	**OPTIONAL** Coolant Bolt	**OPTIONAL** Torque Driver Handle	**OPTIONAL** Preset Torque Bit	**OPTIONAL** Torque Driver Bit
1DJ1F	SM30-085-10	DS-T09W	-	-	DS-A00-.25-S	DT-18-.25	DS-T09B
DJ5F-20R01	SM30-085-10	DS-T09W	SD-06-46	SD-06-89	DS-A00-.25-S	DT-18-.25	DS-T09B
DJ5F-20R02	SM30-085-10	DS-T09W	SD-06-46	SD-06-89	DS-A00-.25-S	DT-18-.25	DS-T09B
DJ5F-25R01	SM30-085-10	DS-T09W	SD-06-46	SD-06-89	DS-A00-.25-S	DT-18-.25	DS-T09B
DJ5F-30R01	SM30-085-10	DS-T09W	SD-08-46	SD-08-92	DS-A00-.25-S	DT-18-.25	DS-T09B
DJ5F-30R02	SM30-085-10	DS-T09W	SD-08-46	SD-08-92	DS-A00-.25-S	DT-18-.25	DS-T09B
DJ5F-40R01	SM30-085-10	DS-T09W	SD-12-82	SD-12-99	DS-A00-.25-S	DT-18-.25	DS-T09B
DJ6F-40R01	SM30-085-10	DS-T09W	SD-12-82	SD-12-99	DS-A00-.25-S	DT-18-.25	DS-T09B

DIPOSTRIO™ 13 SERIES 1DJ1P (WELDON SHANK)

90° ROUGH & FINISH END MILL (13MM INSERT)

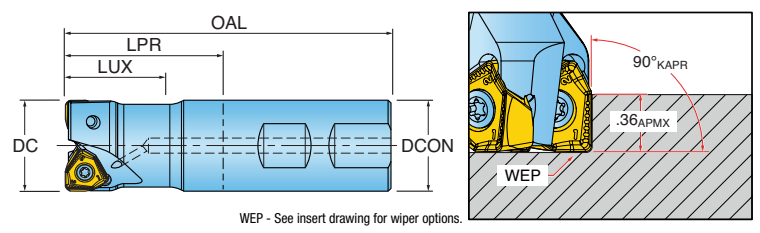

Part Number	DC Cutting Dia.	LUX Usable Length Max.	LPR Protruding Length	OAL Overall Length	ZEFF Effective Teeth	DCON Shank Dia.
1DJ1P-1202281R01	1.250	2.20	2.25	4.50	2	1.250
1DJ1P-1502281R01	1.500	2.25	2.25	4.50	3	1.250



DIPOSTRIO™ 13 SERIES DJ5P, DJ6P

90° ROUGH & FINISH FACE MILL (13MM INSERT)

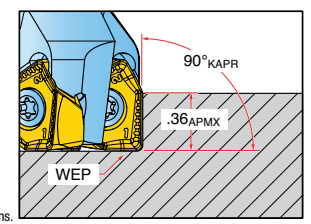
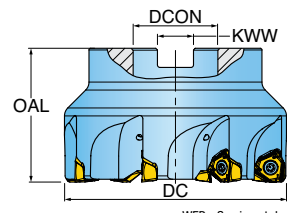

WEP - See insert drawing for wiper options.

Part Number	DC Cutting Dia.	DCX Cutting Dia. Max.	OAL Overall Length	ZEFF Effective Teeth	DCON Shank Dia.	KWW Keyway	CSP Coolant
DJ5P-20R01	2.000	2.000	1.57	5	0.750	0.312	Yes
DJ6P-20R01	2.000	2.000	1.57	4	0.750	0.312	Yes
DJ5P-25R01	2.500	2.500	1.57	6	0.750	0.312	Yes
DJ5P-30R01	3.000	3.000	1.75	7	1.000	0.375	Yes
DJ5P-30R02	3.000	3.000	1.75	9	1.000	0.375	Yes
DJ5P-40R01	4.000	4.000	2.38	8	1.500	0.625	Yes
DJ5P-40R02	4.000	4.000	2.38	11	1.500	0.625	Yes
DJ5P-60R01	6.000	6.000	2.00	16	1.500	0.625	No
DJ6P-60R01	6.000	6.000	2.00	12	1.500	0.625	No

DIPOSTRIO™ 13 INSERTS

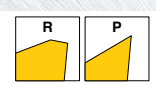

WNGU13_R

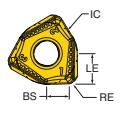



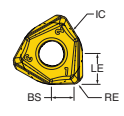
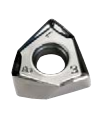





WNGU13_FR-P



Part Number	Application	RE/BCH Corner Radius/ Chamfer	BS Wiper Length	LE Cutting Edge Length	IC Inscribed Circle Dia.	S Thickness (To Cutting Edge)	NOI Number of Indexes	IH Insert Hand	Grade	IN2505	IN2510	IN2530	IN2540	IN10K
WNGU130604R	Multi-Purpose	0.015 R	0.086	0.360	0.514	0.265	6	Right		•				
WNGU130608R	Multi-Purpose	0.031 R	0.078	0.360	0.514	0.265	6	Right		•	•	•	•	
WNGU130616R	Multi-Purpose	0.062 R	0.047	0.360	0.514	0.265	6	Right		•	•	•	•	
WNGU130604FR-P	Non-Ferrous	0.015 R	0.086	0.360	0.514	0.265	6	Right						•
WNGU130608FR-P	Non-Ferrous	0.031 R	0.078	0.360	0.514	0.265	6	Right						•



DIPOSTRIO™ 13 HARDWARE

								
	Insert Screw	Driver Handle	Driver Blade	Retention Bolt	Coolant Bolt	Torque Driver Handle	Preset Torque Bit	Torque Driver Bit
1DJ1P	SM40-100-R0	DS-A00T	DS-T156B	-	-	DS-A00-.25-T	DT-35-.25	DS-T15B1
DJ5P-20R01	SM40-100-R0	DS-A00T	DS-T156B	SD-06-46	SD-06-89	DS-A00-.25-T	DT-35-.25	DS-T15B1
DJ6P-20R01	SM40-100-R0	DS-A00T	DS-T156B	SD-06-46	SD-06-89	DS-A00-.25-T	DT-35-.25	DS-T15B1
DJ5P-25R01	SM40-100-R0	DS-A00T	DS-T156B	SD-06-46	SD-06-89	DS-A00-.25-T	DT-35-.25	DS-T15B1
DJ5P-30R01	SM40-100-R0	DS-A00T	DS-T156B	SD-08-46	SD-08-92	DS-A00-.25-T	DT-35-.25	DS-T15B1
DJ5P-30R02	SM40-100-R0	DS-A00T	DS-T156B	SD-08-46	SD-08-92	DS-A00-.25-T	DT-35-.25	DS-T15B1
DJ5P-40R01	SM40-100-R0	DS-A00T	DS-T156B	SD-12-82	SD-12-99	DS-A00-.25-T	DT-35-.25	DS-T15B1
DJ5P-40R02	SM40-100-R0	DS-A00T	DS-T156B	SD-12-82	SD-12-99	DS-A00-.25-T	DT-35-.25	DS-T15B1
DJ6P-60R01	SM40-100-R0	DS-A00T	DS-T156B	-	-	DS-A00-.25-T	DT-35-.25	DS-T15B1

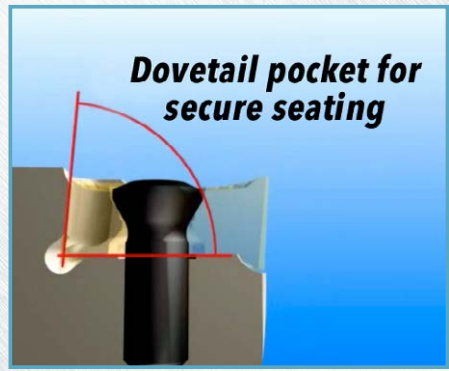
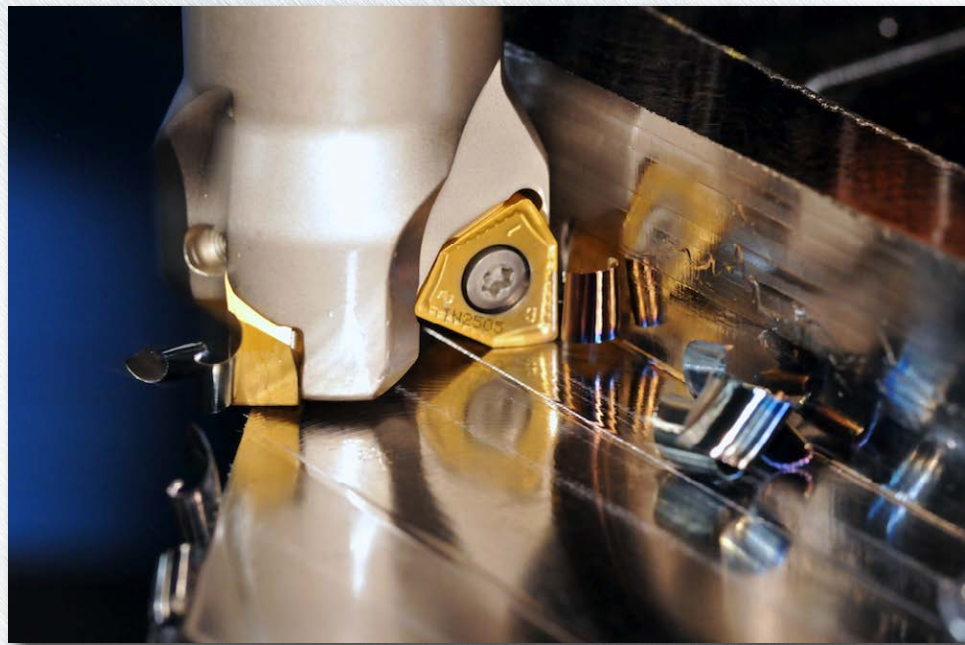



DIPOSTRIO™ 04 OPERATING GUIDELINES

ISO	Materials			Vc Cutting Speed SFM	fz* Feed/Tooth (inch)	Harder <-----> Tougher					Coolant
	Mat'l Group #VDI 3323	Type	Examples			IN2504	IN10K	IN2505	IN4030 IN2530	IN2035	
P	1 - 5	Non-alloy Steel	1018, A36, 1045, A572, 1070	400-1000	.003-.005	3		2	1		No
	6 - 9	Low-alloy Steel	4140, 4340, P20, 8620, 300M	350-700							
	10 - 11	High-alloy Steel	H13, A2, D2, M2, T1	300-600							
M	12 - 13	Stainless Steel (Fer- ritic & Martensitic)	410, 416, 440	350-600	.003-.005			3	2	1	Yes
	14	Stainless Steel (Austenitic)	303, 304, 316, 15-5, 17-4	300-550							May not be required at high speeds
K	15 - 16	Gray Cast Iron	CLS. 20, 30, 45	500-1000	.003-.006	1		2	3		No
	17 - 20	Nodular Cast Iron	60-40-18, 100-70-03	400-800							
N	21 - 30	Aluminum	7075, 6061	1000-3000	.003-.007		1				Yes
S	31 - 35	High-Temp Alloys	Inconel, Hastelloy, Nimonic, Monel	65-150	.003-.005			2	3	1	Yes
	36 - 37	Titanium Alloys	6Al-4V, 5Al-5Mo-5V-3Cr	85-200							
H	38 - 39	Hardened Steel >48	A2, O1, D2	130-250	.003-.004	1		2			No

Note: Feed and speed recommendations are starting operating parameters. They are only guidelines from which further optimization should take place. Operating parameters are influenced by many machining variables. These variables may cause for reductions in feeds and speed or dramatic increases. Additionally, DOC and WOC may need to be revised to optimize the tools performance.



DIPOSTRIO™ 06 OPERATING GUIDELINES

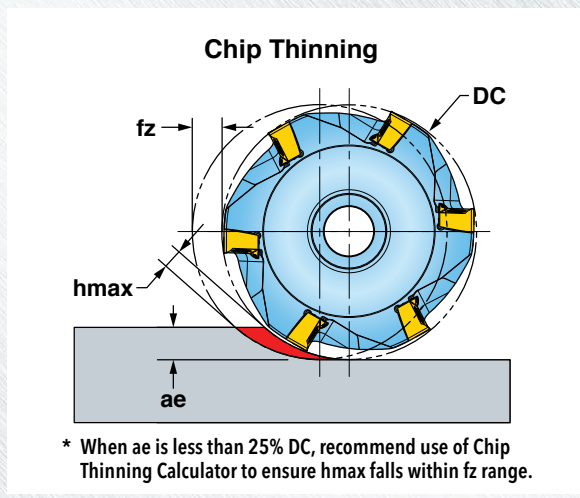

* When ae is less than 25% DC, recommend use of Chip Thinning Calculator to ensure hmax falls within fz range.

ISO	Materials			Vc Cutting Speed SFM	fz* Feed/Tooth (inch)	Harder <-----> Tougher					Coolant
	Mat'l Group #VDI 3323	Type	Examples			IN2504	IN10K	IN2505	IN4030 IN2530	IN6535 IN2035	
P	1 - 5	Non-alloy Steel	1018, A36, 1045, A572, 1070	400-1000	.003-.008	3		2	1		No
	6 - 9	Low-alloy Steel	4140, 4340, P20, 8620, 300M	350-700							
	10 - 11	High-alloy Steel	H13, A2, D2, M2, T1	300-600							
M	12 - 13	Stainless Steel (Ferritic & Martensitic)	410, 416, 440	350-600	.003-.007			3	2	1	Yes
	14	Stainless Steel (Austenitic)	303, 304, 316, 15-5, 17-4	300-550							May not be required at high speeds
K	15 - 16	Gray Cast Iron	CLS. 20, 30, 45	500-1000	.003-.008	1		2	3		No
	17 - 20	Nodular Cast Iron	60-40-18, 100-70-03	400-800							
N	21 - 30	Aluminum	7075, 6061	1000-3000	.003-.008		1				Yes
S	31 - 35	High-Temp Alloys	Inconel, Hastelloy, Nimonic, Monel	65-150	.003-.006			2	3	1	Yes
	36 - 37	Titanium Alloys	6Al-4V, 5Al-5Mo-5V-3Cr	85-200							
H	38 - 39	Hardened Steel >48	A2, O1, D2	130-250	.003-.005	1		2			No

Note: Feed and speed recommendations are starting operating parameters. They are only guidelines from which further optimization should take place. Operating parameters are influenced by many machining variables. These variables may cause for reductions in feeds and speed or dramatic increases. Additionally, DOC and WOC may need to be revised to optimize the tools performance.



DIPOSTRIO™ 09 OPERATING GUIDELINES

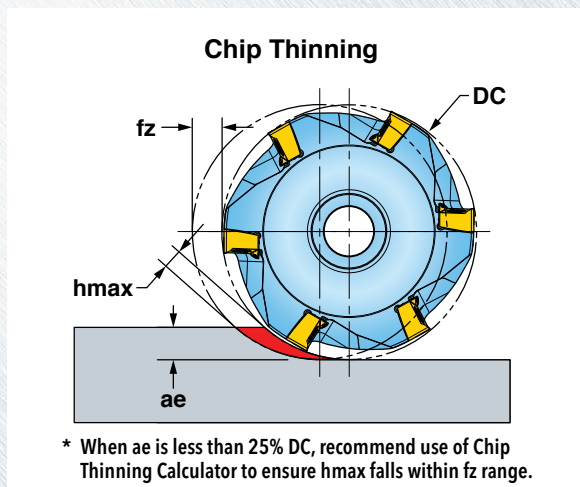

ISO	Materials			Vc Cutting Speed SFM	fz* Feed/Tooth (inch)	Harder <-----> Tougher					Coolant
	Mat'l Group #VDI 3323	Type	Examples			IN2540	IN10K	IN2510	IN2505	IN2530	
P	1 - 5	Non-alloy Steel	1018, A36, 1045, A572, 1070	400-1000	.003-.008	3			2	1	No
	6 - 9	Low-alloy Steel	4140, 4340, P20, 8620, 300M	350-700							
	10 - 11	High-alloy Steel	H13, A2, D2, M2, T1	300-600							
M	12 - 13	Stainless Steel (Ferritic & Martensitic)	410, 416, 440	350-600	.003-.007	3			2	1	Yes
	14	Stainless Steel (Austenitic)	303, 304, 316, 15-5, 17-4	300-550							May not be required at high speeds
K	15 - 16	Gray Cast Iron	CLS. 20, 30, 45	500-1000	.003-.008			1	2		No
	17 - 20	Nodular Cast Iron	60-40-18, 100-70-03	400-800							
N	21 - 30	Aluminum	7075, 6061	1000-3000	.003-.008		1				Yes
S	31 - 35	High-Temp Alloys	Inconel, Hastelloy, Nimonic, Monel	65-150	.003-.006				1	2	Yes
	36 - 37	Titanium Alloys	6Al-4V, 5Al-5Mo-5V-3Cr	85-200							

Note: Feed and speed recommendations are starting operating parameters. They are only guidelines from which further optimization should take place. Operating parameters are influenced by many machining variables. These variables may cause for reductions in feeds and speed or dramatic increases. Additionally, DOC and WOC may need to be revised to optimize the tools performance.

DIPOSTRIO™ 13 OPERATING GUIDELINES

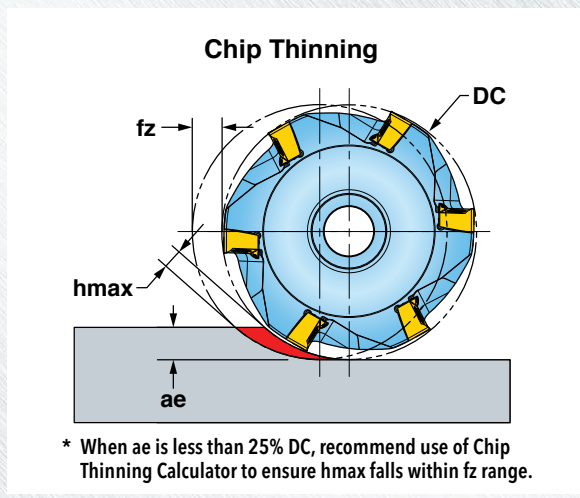

ISO	Materials			Vc Cutting Speed SFM	fz* Feed/Tooth (inch)	Harder <-----> Tougher					Coolant
	Mat'l Group #VDI 3323	Type	Examples			IN2504	IN2540	IN10K	IN2510	IN2505	
P	1 - 5	Non-alloy Steel	1018, A36, 1045, A572, 1070	400-1000	.003-.010	4	3		2	1	No
	6 - 9	Low-alloy Steel	4140, 4340, P20, 8620, 300M	350-700							
	10 - 11	High-alloy Steel	H13, A2, D2, M2, T1	300-600							
M	12 - 13	Stainless Steel (Ferritic & Martensitic)	410, 416, 440	350-600	.003-.008		3		2	1	Yes
	14	Stainless Steel (Austenitic)	303, 304, 316, 15-5, 17-4	300-550							
K	15 - 16	Gray Cast Iron	CLS. 20, 30, 45	500-1000	.003-.010	1		2	3		No
	17 - 20	Nodular Cast Iron	60-40-18, 100-70-03	400-800							
N	21 - 30	Aluminum	7075, 6061	1000-3000	.003-.010		1				Yes
S	31 - 35	High-Temp Alloys	Inconel, Hastelloy, Nimonic, Monel	65-150	.003-.006				1	2	Yes
	36 - 37	Titanium Alloys	6Al-4V, 5Al-5Mo-5V-3Cr	85-200							
H	38 - 39	Hardened Steel >48	A2, O1, D2	130-250	.003-.005	1			2		No

Note: Feed and speed recommendations are starting operating parameters. They are only guidelines from which further optimization should take place. Operating parameters are influenced by many machining variables. These variables may cause for reductions in feeds and speed or dramatic increases. Additionally, DOC and WOC may need to be revised to optimize the tools performance.



DIPOSTRIO™ 06 RAMPING DATA

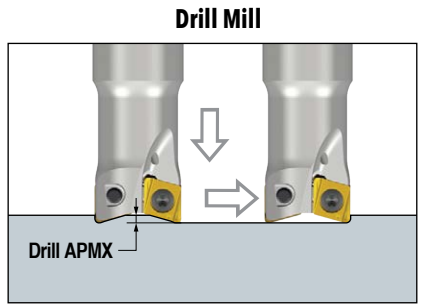
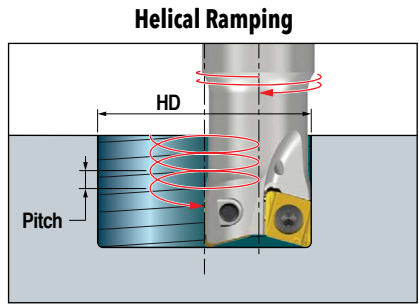
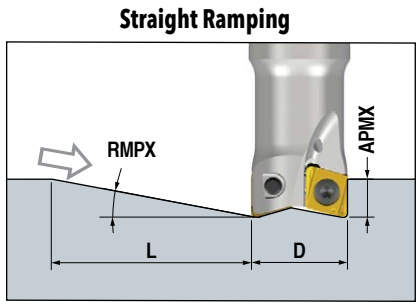

DC Cutter Diameter	Straight Ramp			Helical Ramp			Drill Mill
	RMPX Ramp Angle Max.	APMX Depth of Cut Max.	L Ramp Length Min.	HD Hole Dia. Min.	HD Hole Dia. Max.	Pitch Max.	Drill APMX Depth of Cut Max.
1.000	2.7	0.23	4.8	1.54		0.079	0.035
					2.00	0.148	
1.250	2.0	0.23	6.5	2.04		0.086	0.035
					2.50	0.136	
1.500	1.6	0.23	8.2	2.54		0.090	0.034
					3.00	0.131	
2.000	1.4	0.23	9.4	3.48		0.113	0.044
					4.00	0.153	
2.500	1.8	0.23	7.3	4.40		0.188	0.068
					5.00	0.230	
3.000	2.1	0.23	6.2	5.30		0.230	0.100
					6.00	0.230	
4.000	2.2	0.23	5.9	7.15		0.230	0.137
					8.00	0.230	