



# CHIP SURFER™

MILLING PRODUCTS

**Tip Series: Style**

- 45V: Flat Bottom (Plunge Mill / Spotface)
- 45D: 90° (Drill Mill / Ramp)
- CND: Flat Bottom (Drill / C'Bore)
- 45Z: Center Drill (Drill / C'Sink)
- 45Z\_RA: 90° & 145° NC Spot Drill (Spot Drill / C'Sink)

**Diameter Range**

- 45V: .312"-.625" (8-16mm)
- 45D: .312"-.625" (7.8-16mm)
- CND: 8-20mm
- 45Z: .13"-.25" (3.2-6.4mm)
- 45Z\_RA: .312"-.625" (8-16mm)

**Adaptions**

T5, T6, T8, T10, T12

**Materials**

Steel, Stainless Steel, Iron, Hi-Temp Alloys, Titanium, Aluminum



**NEW** 45Z\_RA  
inch + metric

## Drill, C'Sink, C'Bore, Spotface, Plunge-Mill, Drill-Mill... Chip Surfer Tips that Leverage the Strong Z-Axis

Ingersoll is pleased to announce the expansion of Chip Surfer tips for plunging, 90° drill-milling, spotfacing, counterboring and drilling. With the Z-Axis being the strongest axis, these operations are often preferred for metal removal in unrigid and long L/D ratio conditions. Carbide Chip Surfer tips can be changed on the machine and repeat within +/- .0005" and the same shank can be used with a vast array of other tip styles... making it a very user-friendly, accurate and flexible tool system.

**Features & Benefits:**

- 45V Plunge Tips are equipped with a flat bottom face and backdraft side, resulting in single point contact for minimal radial pressure; ideal for long reaches, especially when relieving 90° corners for finish operations
- 45D Drill Mill Tips generate 90° shoulders, ramp aggressively and drill up to .35xD; an economical shoulder mill solution and ideal for producing blind key-slots
- CND Flat Bottom Drills and are designed to accommodate entry into inclined surfaces; ideal for C'Bores
- 45Z Center Drills comply with ANSI B94 & DIN 332
- 45Z\_RA NC Spot Drills facilitate accurate hole locating without use of a guide bushing



# CHIPSURFER™ SERIES 45V

SOLID CARBIDE FLAT BOTTOM PLUNGE/SPOT TIP, CENTER CUTTING

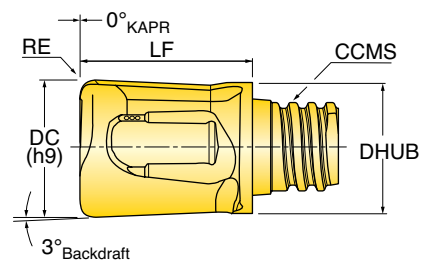

Cutter Number	DC Cutting Diameter	RE Corner Radius	LF Functional Length	ZEFF Effective Flutes	CCMS Connection Code	DHUB Hub Diameter
45V-3130TQRA01	0.312	0.015	0.400	2	Chip Surfer T05	0.300
45V-3130TQRA03	0.312	0.031	0.400	2	Chip Surfer T05	0.300
45V-3738T6RA01	0.375	0.015	0.480	2	Chip Surfer T06	0.364
45V-3738T6RA03	0.375	0.031	0.480	2	Chip Surfer T06	0.364
45V-5045T8RA01	0.500	0.015	0.600	2	Chip Surfer T08	0.480
45V-5045T8RA03	0.500	0.031	0.600	2	Chip Surfer T08	0.480
45V-6260TRRA01	0.625	0.015	0.750	2	Chip Surfer T10	0.600
45V-6260TRRA03	0.625	0.031	0.750	2	Chip Surfer T10	0.600

Full diameter drill depth not to exceed .35 x D.  
 When assembling, be sure carbide tip is seated firmly on shank with no gap. No lubricant on adaption. Wrenches sold separately.

## HARDWARE

	**OPTIONAL** Wrench	**OPTIONAL** Torque Driver	CCMS Connection Code	Torque Value
45V-3130TQRA01	WS-0043	DT-60-04	T05	60in/lbs
45V-3130TQRA03	WS-0043	DT-60-04	T05	60in/lbs
45V-3738T6RA01	WS-0029	DT-90-05	T06	90in/lbs
45V-3738T6RA03	WS-0029	DT-90-05	T06	90in/lbs
45V-5045T8RA01	WS-0030	DT-130-07	T08	130in/lbs
45V-5045T8RA03	WS-0030	DT-130-07	T08	130in/lbs
45V-6260TRRA01	WS-0044	DT-250-08	T10	250in/lbs
45V-6260TRRA03	WS-0044	DT-250-08	T10	250in/lbs



## CHIPSURFER™ SERIES 45V - METRIC

SOLID CARBIDE FLAT BOTTOM PLUNGE/SPOT TIP, CENTER CUTTING

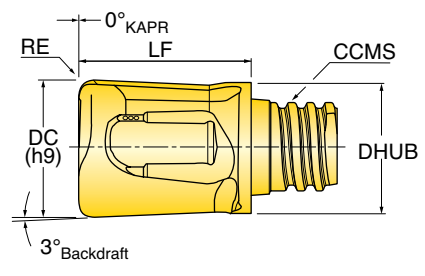

Cutter Number	DC Cutting Diameter	RE Corner Radius	LF Functional Length	ZEFF Effective Flutes	CCMS Connection Code	DHUB Hub Diameter
45V08008TQRA04	8.00 mm	0.40 mm	10.00 mm	2	Chip Surfer T05	7.60 mm
45V10009T6RA04	10.00 mm	0.40 mm	12.00 mm	2	Chip Surfer T06	9.60 mm
45V12010T8RA08	12.00 mm	0.80 mm	14.20 mm	2	Chip Surfer T08	11.50 mm
45V16015TRRA08	16.00 mm	0.80 mm	19.00 mm	2	Chip Surfer T10	15.20 mm

Full diameter drill depth not to exceed .35 x D.  
 When assembling, be sure carbide tip is seated firmly on shank with no gap. No lubricant on adaption. Wrenches sold separately.

## HARDWARE

	**OPTIONAL** Wrench	**OPTIONAL** Torque Driver	CCMS Connection Code	Torque Value
45V08008TQRA04	WS-0043	DT-60-04	T05	60in/lbs
45V10009T6RA04	WS-0029	DT-90-05	T06	90in/lbs
45V12010T8RA08	WS-0030	DT-130-07	T08	130in/lbs
45V16015TRRA08	WS-0044	DT-250-08	T10	250in/lbs

# CHIPSURFER™ SERIES 45V-P

SOLID CARBIDE FLAT BOTTOM PLUNGE/SPOT FOR ALUMINUM, CENTER CUTTING

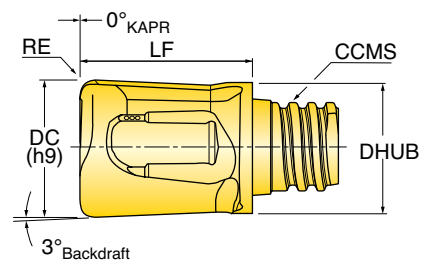

Cutter Number	DC Cutting Diameter	RE Corner Radius	LF Functional Length	ZEFF Effective Flutes	CCMS Connection Code	DHUB Hub Diameter
45V-3130TQRA01-P	0.312	0.015	0.400	2	Chip Surfer T05	0.300
45V-3738T6RA01-P	0.375	0.015	0.480	2	Chip Surfer T06	0.360
45V-5045T8RA01-P	0.500	0.015	0.600	2	Chip Surfer T08	0.480
45V-6260TRRA01-P	0.625	0.015	0.750	2	Chip Surfer T10	0.600

Full diameter drill depth not to exceed .35 x D.  
 When assembling, be sure carbide tip is seated firmly on shank with no gap. No lubricant on adaption. Wrenches sold separately.

## HARDWARE

	**OPTIONAL** Wrench	**OPTIONAL** Torque Driver	CCMS Connection Code	Torque Value
45V-3130TQRA01-P	WS-0043	DT-60-04	T05	60in/lbs
45V-3738T6RA01-P	WS-0029	DT-90-05	T06	90in/lbs
45V-5045T8RA01-P	WS-0030	DT-130-07	T08	130in/lbs
45V-6260TRRA01-P	WS-0044	DT-250-08	T10	250in/lbs



# CHIPSURFER™ SERIES 45V-P - METRIC

SOLID CARBIDE FLAT BOTTOM PLUNGE/SPOT FOR ALUMINUM, CENTER CUTTING

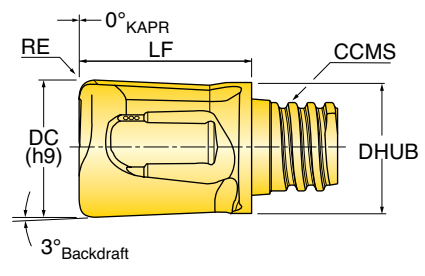

Cutter Number	DC Cutting Diameter	RE Corner Radius	LF Functional Length	ZEFF Effective Flutes	CCMS Connection Code	DHUB Hub Diameter
45V08008TQRA04-P	8.00 mm	0.40 mm	10.00 mm	2	Chip Surfer T05	7.60 mm
45V10009T6RA04-P	10.00 mm	0.40 mm	12.00 mm	2	Chip Surfer T06	9.60 mm
45V12010T8RA04-P	12.00 mm	0.40 mm	14.20 mm	2	Chip Surfer T08	11.50 mm
45V16015TRRA04-P	16.00 mm	0.40 mm	19.00 mm	2	Chip Surfer T10	15.20 mm

Full diameter drill depth not to exceed .35 x D.  
 When assembling, be sure carbide tip is seated firmly on shank with no gap. No lubricant on adaption. Wrenches sold separately.

## HARDWARE

	**OPTIONAL** Wrench	**OPTIONAL** Torque Driver	CCMS Connection Code	Torque Value
45V08008TQRA04-P	WS-0043	DT-60-04	T05	60in/lbs
45V10009T6RA04-P	WS-0029	DT-90-05	T06	90in/lbs
45V12010T8RA04-P	WS-0030	DT-130-07	T08	130in/lbs
45V16015TRRA04-P	WS-0044	DT-250-08	T10	250in/lbs



# CHIP SURFER™ SERIES 45D

SOLID CARBIDE DRILL-MILL TIP, 90°, CENTER CUTTING

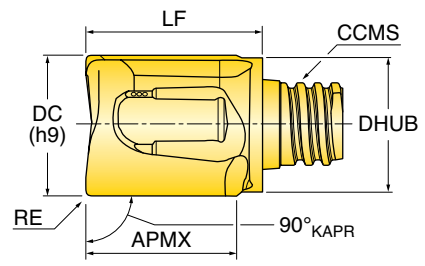

Cutter Number	DC Cutting Diameter	RE/CHW Corner Radius/ Chamfer	APMX Depth of Cut Max.	LF Functional Length	ZEFF Effective Flutes	FHA Flute Helix Angle	CCMS Connection Code	DHUB Hub Diameter
45D-3131TQRA01	0.312	0.015 R	0.310	0.390	2	10	Chip Surfer T05	0.300
45D-3738T6RA01	0.375	0.015 R	0.380	0.480	2	10	Chip Surfer T06	0.364
45D-5045T8RA01	0.500	0.015 R	0.450	0.600	2	10	Chip Surfer T08	0.480
45D-6263TRRA01	0.625	0.015 R	0.600	0.750	2	10	Chip Surfer T10	0.600

Full dia. drill depth not to exceed .35 x DC.  
When assembling, be sure carbide tip is seated firmly on shank with no gap. No lubricant on adaption. Wrenches sold separately.

## HARDWARE

	**OPTIONAL** Wrench	**OPTIONAL** Torque Driver	CCMS Connection Code	Torque Value
45D-3131TQRA01	WS-0043	DT-60-04	T05	60in/lbs
45D-3738T6RA01	WS-0029	DT-90-05	T06	90in/lbs
45D-5045T8RA01	WS-0030	DT-130-07	T08	130in/lbs
45D-6263TRRA01	WS-0044	DT-250-08	T10	250in/lbs



# CHIP SURFER™ SERIES 45D - METRIC

SOLID CARBIDE DRILL-MILL TIP, 90°, CENTER CUTTING

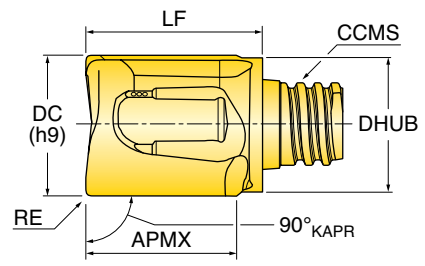



Cutter Number	DC Cutting Diameter	RE/CHW Corner Radius/ Chamfer	APMX Depth of Cut Max.	LF Functional Length	ZEFF Effective Flutes	FHA Flute Helix Angle	CCMS Connection Code	DHUB Hub Diameter	IN2005	IN2006
45D07807TQRA02	7.80 mm	0.200 R	7.50 mm	10.00 mm	2	10	Chip Surfer T05	7.60 mm	•	
45D08007TQRA10	8.00 mm	1.000 R	7.40 mm	10.00 mm	2	10	Chip Surfer T05	7.60 mm	•	
45D08007TQRA20	8.00 mm	2.000 R	7.40 mm	10.00 mm	2	10	Chip Surfer T05	7.60 mm	•	
45D08008TQRA04	8.00 mm	0.400 R	8.00 mm	10.00 mm	2	10	Chip Surfer T05	7.60 mm	•	
45D08008TQRA04	8.00 mm	0.400 R	7.90 mm	10.00 mm	2	10	Chip Surfer T05	7.60 mm		•
45D08008TQRA10	8.00 mm	1.000 R	7.50 mm	10.00 mm	2	10	Chip Surfer T05	7.60 mm		•
45D08008TQRA20	8.00 mm	2.000 R	7.50 mm	10.00 mm	2	10	Chip Surfer T05	7.60 mm		•
45D09809T6RA03	9.80 mm	0.300 R	9.00 mm	12.40 mm	2	10	Chip Surfer T06	9.50 mm	•	
45D10009T6RA04	10.00 mm	0.400 R	9.00 mm	12.40 mm	2	10	Chip Surfer T06	9.50 mm	•	
45D10009T6RA04	10.00 mm	0.400 R	8.90 mm	12.40 mm	2	10	Chip Surfer T06	9.50 mm		•
45D10009T6RA10	10.00 mm	1.000 R	9.00 mm	12.40 mm	2	10	Chip Surfer T06	9.50 mm	•	
45D10009T6RA10	10.00 mm	1.000 R	8.90 mm	12.40 mm	2	10	Chip Surfer T06	9.50 mm		•
45D10009T6RA20	10.00 mm	2.000 R	9.00 mm	12.40 mm	2	10	Chip Surfer T06	9.50 mm	•	
45D10009T6RA20	10.00 mm	2.000 R	8.90 mm	12.40 mm	2	10	Chip Surfer T06	9.50 mm		•
45D11710T8RA03	11.70 mm	0.300 R	10.00 mm	14.20 mm	2	10	Chip Surfer T08	11.50 mm	•	
45D12010T8RA04	12.00 mm	0.400 R	10.00 mm	14.20 mm	2	10	Chip Surfer T08	11.50 mm	•	
45D12010T8RA04	12.00 mm	0.400 R	9.90 mm	14.20 mm	2	10	Chip Surfer T08	11.50 mm		•
45D12010T8RA10	12.00 mm	1.000 R	10.00 mm	14.20 mm	2	10	Chip Surfer T08	11.50 mm	•	
45D12010T8RA10	12.00 mm	1.000 R	9.90 mm	14.20 mm	2	10	Chip Surfer T08	11.50 mm		•
45D12010T8RA20	12.00 mm	2.000 R	10.00 mm	14.20 mm	2	10	Chip Surfer T08	11.50 mm	•	
45D12010T8RA20	12.00 mm	2.000 R	9.90 mm	14.20 mm	2	10	Chip Surfer T08	11.50 mm		•
45D14012T8RA04	14.00 mm	0.400 R	12.00 mm	15.00 mm	2	10	Chip Surfer T08	11.50 mm	•	
45D15715TRRA03	15.70 mm	0.300 R	15.00 mm	19.00 mm	2	10	Chip Surfer T10	15.20 mm	•	
45D16015TRRA04	16.00 mm	0.400 R	15.00 mm	19.00 mm	2	10	Chip Surfer T10	15.20 mm	•	
45D16015TRRA04	16.00 mm	0.400 R	14.90 mm	19.00 mm	2	10	Chip Surfer T10	15.20 mm		•
45D16015TRRA08	16.00 mm	0.800 R	15.00 mm	19.00 mm	2	10	Chip Surfer T10	15.20 mm	•	
45D16015TRRA08	16.00 mm	0.800 R	14.90 mm	19.00 mm	2	10	Chip Surfer T10	15.20 mm		•

Full dia. drill depth not to exceed .35 x DC.  
 When assembling, be sure carbide tip is seated firmly on shank with no gap. No lubricant on adaption. Wrenches sold separately.



## SERIES 45D - METRIC HARDWARE

	 **OPTIONAL** Wrench	 **OPTIONAL** Torque Driver	CCMS Connection Code	Torque Value
45D07807TQRA02	WS-0043	DT-60-04	T05	60in/lbs
45D08007TQRA10	WS-0043	DT-60-04	T05	60in/lbs
45D08007TQRA20	WS-0043	DT-60-04	T05	60in/lbs
45D08008TQRA04	WS-0043	DT-60-04	T05	60in/lbs
45D08008TQRA04	WS-0043	DT-60-04	T05	60in/lbs
45D08008TQRA10	WS-0043	DT-60-04	T05	60in/lbs
45D08008TQRA20	WS-0043	DT-60-04	T05	60in/lbs
45D09809T6RA03	WS-0029	DT-90-05	T06	90in/lbs
45D10009T6RA04	WS-0029	DT-90-05	T06	90in/lbs
45D10009T6RA04	WS-0029	DT-90-05	T06	90in/lbs
45D10009T6RA10	WS-0029	DT-90-05	T06	90in/lbs
45D10009T6RA10	WS-0029	DT-90-05	T06	90in/lbs
45D10009T6RA20	WS-0029	DT-90-05	T06	90in/lbs
45D10009T6RA20	WS-0029	DT-90-05	T06	90in/lbs
45D11710T8RA03	WS-0030	DT-130-07	T08	130in/lbs
45D12010T8RA04	WS-0030	DT-130-07	T08	130in/lbs
45D12010T8RA04	WS-0030	DT-130-07	T08	130in/lbs
45D12010T8RA10	WS-0030	DT-130-07	T08	130in/lbs
45D12010T8RA10	WS-0030	DT-130-07	T08	130in/lbs
45D12010T8RA20	WS-0030	DT-130-07	T08	130in/lbs
45D12010T8RA20	WS-0030	DT-130-07	T08	130in/lbs
45D14012T8RA04	WS-0030	DT-130-07	T08	130in/lbs
45D15715TRRA03	WS-0044	DT-250-08	T10	250in/lbs
45D16015TRRA04	WS-0044	DT-250-08	T10	250in/lbs
45D16015TRRA04	WS-0044	DT-250-08	T10	250in/lbs
45D16015TRRA08	WS-0044	DT-250-08	T10	250in/lbs
45D16015TRRA08	WS-0044	DT-250-08	T10	250in/lbs





# CHIPSURFER™ SERIES CND

## SOLID CARBIDE FLAT BOTTOM DRILL/C'BORE TIP

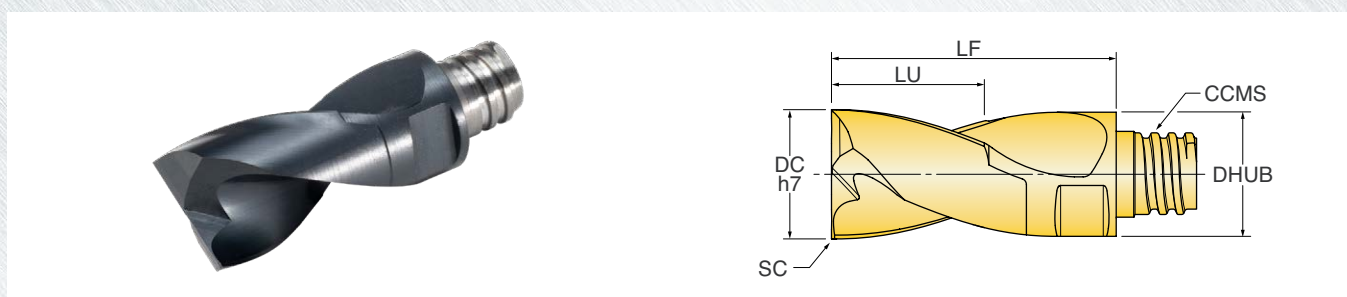
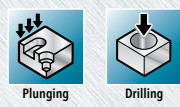

Cutter Number	DC Cutting Diameter	LF Functional Length	LU Usable Length	ZEFF Effective Flutes	CCMS Connection Code	DHUB Hub Diameter
<b>NEW</b> CND0792TQR01	0.312	0.714	0.520	2	Chip Surfer T05	0.300
<b>NEW</b> CND0952T6R01	0.375	0.872	0.640	2	Chip Surfer T06	0.364
<b>NEW</b> CND1112T8R01	0.438	1.070	0.750	2	Chip Surfer T08	0.480
<b>NEW</b> CND1270T8R01	0.500	1.070	0.750	2	Chip Surfer T08	0.480
<b>NEW</b> CND1587TRR01	0.625	1.328	0.970	2	Chip Surfer T10	0.600
<b>NEW</b> CND1905TSR01	0.750	1.624	1.250	2	Chip Surfer T12	0.720

Full dia. drill depth not to exceed 1.2xDC.  
 When assembling, be sure carbide tip is seated firmly on shank with no gap. No lubricant on adaption. Wrenches sold separately.

## HARDWARE

	<b>**OPTIONAL**</b> Wrench	<b>**OPTIONAL**</b> Torque Driver	CCMS Connection Code	Torque Value
CND0792TQR01	WS-0043	DT-60-06	T05	60in/lbs
CND0952T6R01	WS-0029	DT-90-08	T06	90in/lbs
CND1112T8R01 CND1270T8R01	WS-0030	DT-130-10	T08	130in/lbs
CND1587TRR01	WS-0044	DT-250-13	T10	250in/lbs
CND1905TSR01	WS-0059	DT-250-16	T12	250in/lbs



# CHIPSURFER™ SERIES CND - METRIC

SOLID CARBIDE FLAT BOTTOM DRILL/C'BORE TIP

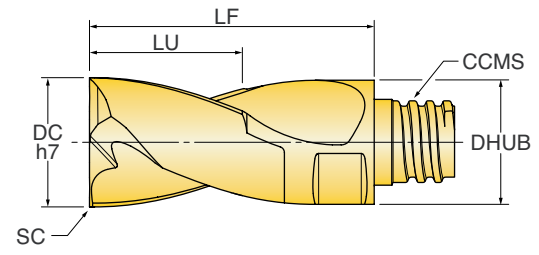
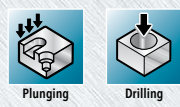

Cutter Number	DC Cutting Diameter	LF Functional Length	LU Usable Length	ZEFF Effective Flutes	CCMS Connection Code	DHUB Hub Diameter
CND0800TQR01	8.00 mm	18.00 mm	10.000	2	Chip Surfer T05	7.70 mm
CND1000T6R01	10.00 mm	22.00 mm	12.000	2	Chip Surfer T06	9.60 mm
CND1200T8R01	12.00 mm	27.00 mm	15.000	2	Chip Surfer T08	11.70 mm
CND1600TRR01	16.00 mm	33.50 mm	20.000	2	Chip Surfer T10	15.30 mm
CND2000TSR01	20.00 mm	41.00 mm	25.000	2	Chip Surfer T12	18.40 mm

Full dia. drill depth not to exceed 1.2xDC.  
 When assembling, be sure carbide tip is seated firmly on shank with no gap. No lubricant on adaption. Wrenches sold separately.

## HARDWARE

	**OPTIONAL** Wrench	**OPTIONAL** Torque Driver	CCMS Connection Code	Torque Value
CND0800TQR01	WS-0043	DT-60-06	T05	60in/lbs
CND1000T6R01	WS-0029	DT-90-08	T06	90in/lbs
CND1200T8R01	WS-0030	DT-130-10	T08	130in/lbs
CND1600TRR01	WS-0044	DT-250-13	T10	250in/lbs
CND2000TSR01	WS-0059	DT-250-16	T12	250in/lbs

# CHIPSURFER™ SERIES 45Z

## SOLID CARBIDE CENTER DRILL TIP

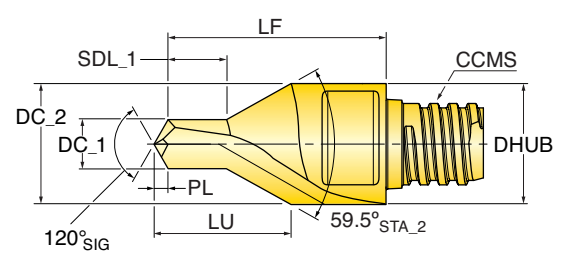

Cutter Number	DC Size Designation (ANSI B94)	DC1 Cutting Dia. 1st Step	DC2 Cutting Dia. 2nd Step	PL Point Length	SDL_1 Step Dia. Length 1st Step	LU Usable Length	LF Functional Length	ZEFF Effective Flutes	FHA Flute Helix Angle	CCMS Connection Code	DHUB Hub Diameter
45Z-1221TQRA06	#4	0.130	0.310	0.037	0.163	0.310	0.552	2	12	Chip Surfer T05	0.310
45Z-1851T8RA09	#5	0.190	0.500	0.054	0.245	0.571	0.855	2	12	Chip Surfer T08	0.500
45Z-2152T8RA09	#6	0.218	0.500	0.063	0.236	0.545	0.846	2	12	Chip Surfer T08	0.500
45Z-2564TRRA11	#7	0.252	0.625	0.072	0.250	0.649	1.030	2	12	Chip Surfer T10	0.625

When assembling, be sure carbide tip is seated firmly on shank with no gap.  
 For cutter number 45Z-1851T8RA09, D2 diameter is larger than ANSI standard.  
 No lubricant on adaption. Wrenches sold separately.

## HARDWARE

	 **OPTIONAL** Wrench	 **OPTIONAL** Torque Driver	CCMS Connection Code	Torque Value
45Z-1221TQRA06	WS-0043	DT-60-06	T05	60in/lbs
45Z-1851T8RA09	WS-0030	DT-130-10	T08	130in/lbs
45Z-2152T8RA09	WS-0030	DT-130-10	T08	130in/lbs
45Z-2564TRRA11	WS-0044	DT-250-13	T10	250in/lbs

# CHIPSURFER™ SERIES 45Z - METRIC

## SOLID CARBIDE CENTER DRILL TIP

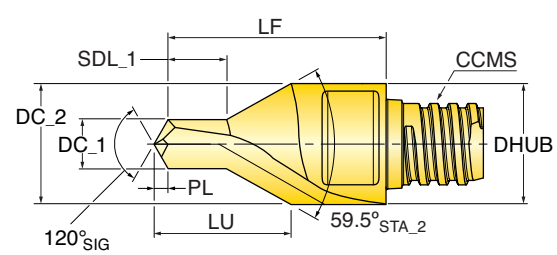

Cutter Number	DC1 Cutting Dia. 1st Step	DC2 Cutting Dia. 2nd Step	SDL_1 Step Dia. Length 1st Step	LF Functional Length	ZEFF Effective Flutes	FHA Flute Helix Angle	CCMS Connection Code
45Z03208TQRA15	3.28 mm	8.00 mm	4.60 mm	15.00 mm	2	12	Chip Surfer T05
45Z04111T6RA19	4.12 mm	10.00 mm	5.90 mm	19.00 mm	2	12	Chip Surfer T06
45Z05113T8RA23	5.13 mm	12.00 mm	7.20 mm	23.00 mm	2	12	Chip Surfer T08
45Z06517TRRA28	6.46 mm	12.00 mm	8.90 mm	28.00 mm	2	12	Chip Surfer T10

When assembling, be sure carbide tip is seated firmly on shank with no gap.  
Aligns with DIN 332..  
No lubricant on adaption. Wrenches sold separately.

## HARDWARE

	 **OPTIONAL** Wrench	 **OPTIONAL** Torque Driver	CCMS Connection Code	Torque Value
45Z03208TQRA15	WS-0043	DT-60-06	T05	60in/lbs
45Z04111T6RA19	WS-0029	DT-90-08	T06	90in/lbs
45Z05113T8RA23	WS-0030	DT-130-10	T08	130in/lbs
45Z06517TRRA28	WS-0044	DT-250-13	T10	250in/lbs



# CHIPSURFER™ SERIES 45Z\_RA

SOLID CARBIDE NC SPOT DRILL TIP

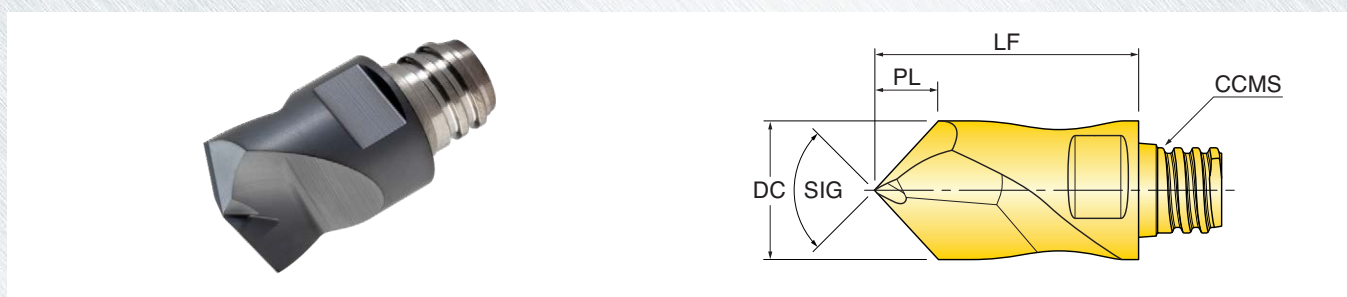

Cutter Number	DC Cutting Diameter	SIG Point Angle	PL Point Length	LF Functional Length	ZEFF Effective Flutes	CCMS Connection Code Machine Side	DHUB Hub Diameter
<b>NEW</b> 45Z-3101TQRA72	0.312	145	0.043	0.393	2	Chip Surfer T05	0.312
<b>NEW</b> 45Z-3701T6RA72	0.375	145	0.050	0.511	2	Chip Surfer T06	0.375
<b>NEW</b> 45Z-5001T6RA72	0.500	145	0.069	0.650	2	Chip Surfer T08	0.500
<b>NEW</b> 45Z-6201TRRA72	0.625	145	0.084	0.807	2	Chip Surfer T10	0.625

When assembling, be sure carbide tip is seated firmly on shank with no gap.  
 No lubricant on adaption.  
 Wrenches sold seperately.

## HARDWARE

	<b>**OPTIONAL**</b> Wrench	<b>**OPTIONAL**</b> Torque Driver	CCMS Connection Code	Torque Value
45Z-3101TQRA72	WS-0043	DT-60-06	T05	60in/lbs
45Z-3701T6RA72	WS-0029	DT-90-08	T06	90in/lbs
45Z-5001T6RA72	WS-0030	DT-130-10	T08	130in/lbs
45Z-6201TRRA72	WS-0044	DT-250-13	T10	250in/lbs



# CHIPSURFER™ SERIES 45Z\_RA - METRIC

## SOLID CARBIDE NC SPOT DRILL TIP

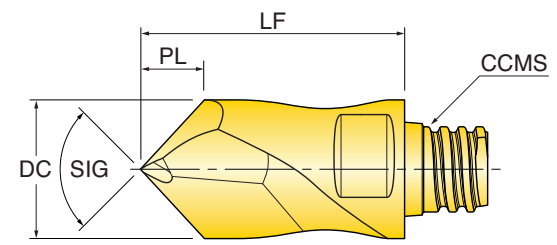

Cutter Number	DC Cutting Diameter	SIG Point Angle	PL Point Length	LF Functional Length	ZEFF Effective Flutes	CCMS Connection Code Machine Side	DHUB Hub Diameter
<b>NEW</b> 45Z08001TQRA72	8.00 mm	145	1.10 mm	10.00 mm	2	Chip Surfer T05	8.00 mm
<b>NEW</b> 45Z08004TQRA45	8.00 mm	90	3.67 mm	15.00 mm	2	Chip Surfer T05	8.00 mm
<b>NEW</b> 45Z10001T6RA72	10.00 mm	145	1.34 mm	13.00 mm	2	Chip Surfer T06	10.00 mm
<b>NEW</b> 45Z10005TQRA45	10.00 mm	90	4.56 mm	19.00 mm	2	Chip Surfer T06	10.00 mm
<b>NEW</b> 45Z12001T8RA72	12.00 mm	145	1.64 mm	16.50 mm	2	Chip Surfer T08	12.00 mm
<b>NEW</b> 45Z12006T6RA45	12.00 mm	90	5.46 mm	23.00 mm	2	Chip Surfer T08	12.00 mm
<b>NEW</b> 45Z16001TRRA72	16.00 mm	145	2.36 mm	20.50 mm	2	Chip Surfer T10	16.00 mm
<b>NEW</b> 45Z16008TRRA45	16.00 mm	90	7.33 mm	28.00 mm	2	Chip Surfer T10	16.00 mm

When assembling, be sure carbide tip is seated firmly on shank with no gap.  
 No lubricant on adaption.  
 Wrenches sold seperately.

## HARDWARE

	**OPTIONAL** Wrench	**OPTIONAL** Torque Driver	CCMS Connection Code	Torque Value
45Z08001TQRA72 45Z08004TQRA45	WS-0043	DT-60-06	T05	60in/lbs
45Z10001T6RA72 45Z10005TQRA45	WS-0029	DT-90-08	T06	90in/lbs
45Z12001T8RA72 45Z12006T6RA45	WS-0030	DT-130-10	T08	130in/lbs
45Z16001TRRA72 45Z16008TRRA45	WS-0044	DT-250-13	T10	250in/lbs

## CHIPSURFER™ OPERATING GUIDELINES: 45V/45V-P • PLUNGE MILL

When plunge milling, radial stepovers (ae) may range from RE (minimum) to .65 x DC (maximum).

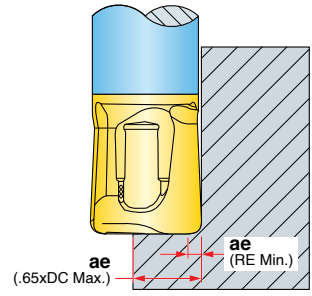

When spotfacing (full diameter), depth of cut (ap) should not exceed .35 x DC.

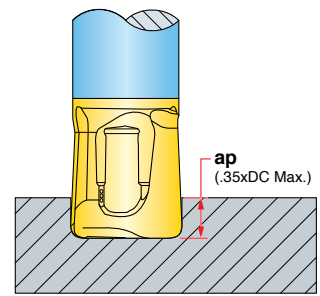

\*Feed / Rev is based on Two-Effective (do not double).

Materials				Plunge Mill Vc Cutting Speed SFM	Spotface Vc Cutting Speed SFM	DC Cutting Dia. (inch)	f* Feed/Rev (inch)	Coolant
ISO	Mat'l Group #VDI 3323	Type	Examples					
P	1 - 5	Non-alloy Steel	1018, A36, 1045, A572, 1070	450-700	170-450	0.312	.004-.008	No
						0.375	.004-.009	
						0.500	.005-.010	
						0.625	.006-.012	
	6 - 9	Low-alloy Steel	4140, 4340, P20, 8620, 300M	400-650	140-350	0.312	.004-.008	
						0.375	.004-.009	
						0.500	.005-.010	
						0.625	.006-.012	
						0.625	.006-.012	
10 - 11	High-alloy Steel	H13, A2, D2, M2, T1	400-600	130-300	0.312	.004-.007		
					0.375	.004-.008		
					0.500	.005-.009		
					0.625	.005-.010		
M	12 - 14	Stainless Steel	410, 416, 440, 303, 304, 316, 15-5, 17-4	200-450	100-230	0.312	.004-.006	May be required at high speeds
						0.375	.005-.007	
						0.500	.006-.008	
						0.625	.006-.009	
K	15 - 18	Iron	CLS. 20, 30, 45, 60-40-18, 100-70-03	500-800	265-550	0.312	.004-.010	No
						0.375	.004-.011	
						0.500	.005-.012	
						0.625	.005-.013	
N	21 - 30	Non Ferrous & Non Metallic	7075, 6061, Duroplastics	800-3000	265-725	0.312	.004-.010	Yes
						0.375	.005-.011	
						0.500	.006-.012	
						0.625	.007-.013	
S	31 - 37	High-Temp, Ti	Inconel, Hastelloy, 6Al-4V, 5Al-5Mo-5V-3Cr	65-250	70-165	0.312	.002-.004	Yes
						0.375	.003-.005	
						0.500	.004-.006	
						0.625	.005-.007	

Note: Feed and speed recommendations are starting operating parameters. They are only guidelines from which further optimization should take place. Operating parameters are influenced by many machining variables. These variables may cause for reductions in feeds and speed or dramatic increases. Additionally, DOC and WOC may need to be revised to optimize the tools performance.



# CHIPSURFER™ OPERATING GUIDELINES: 45D • DRILL MILL

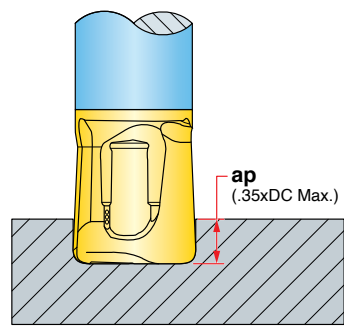

When drilling, depth of cut (ap) should not exceed .35 x DC.

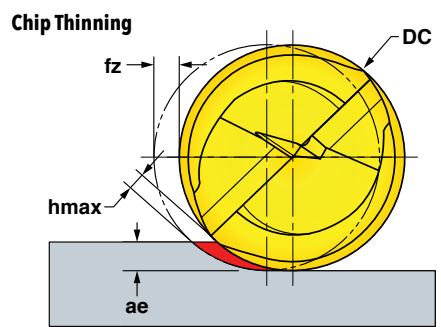

When ae is less than 25% DC, recommend use of Chip Thinning Calculator to ensure hmax is within fz range.

ISO	Materials			Mill Vc Cutting Speed SFM	Drill Vc Cutting Speed SFM	DC Cutting Dia. (inch)	fz* Feed/Tooth (inch)	Coolant
	Mat'l Group #VDI 3323	Type	Examples					
P	1 - 5	Non-alloy Steel	1018, A36, 1045, A572, 1070	450-700	170-450	0.312	.0020-.0040	No
						0.375	.0020-.0045	
						0.500	.0020-.0050	
						0.625	.0020-.0060	
	6 - 9	Low-alloy Steel	4140, 4340, P20, 8620, 300M	400-650	140-350	0.312	.0020-.0040	
						0.375	.0020-.0045	
						0.500	.0020-.0050	
						0.625	.0020-.0060	
	10 - 11	High-alloy Steel	H13, A2, D2, M2, T1	400-600	130-300	0.312	.0020-.0035	
						0.375	.0020-.0040	
						0.500	.0020-.0045	
						0.625	.0020-.0050	
M	12 - 14	Stainless Steel	410, 416, 440, 303, 304, 316, 15-5, 17-4	200-450	100-230	0.312	.0020-.0030	May be required at high speeds
0.375	.0025-.0035							
0.500	.0020-.0040							
0.625	.0020-.0045							
K	15 - 18	Iron	CLS. 20, 30, 45, 60-40-18, 100-70-03	500-800	265-550	0.312	.0020-.0050	No
0.375	.0020-.0055							
0.500	.0020-.0060							
0.625	.0020-.0065							
S	31 - 37	High-Temp, Ti	Inconel, Hastelloy, 6Al-4V, 5Al-5Mo-5V-3Cr	65-250	65-165	0.312	.0010-.0020	Yes
0.375	.0015-.0025							
0.500	.0020-.0030							
0.625	.0020-.0035							
H	38 - 39	Hardened Steel > 48	A2, O1, D2	150-300	65-165	0.312	.0010-.0020	Yes
0.375	.0015-.0025							
0.500	.0020-.0030							
0.625	.0020-.0035							

Note: Feed and speed recommendations are starting operating parameters. They are only guidelines from which further optimization should take place. Operating parameters are influenced by many machining variables. These variables may cause for reductions in feeds and speed or dramatic increases. Additionally, DOC and WOC may need to be revised to optimize the tools performance.



# CHIPSURFER™ OPERATING GUIDELINES: CND • DRILL

When drilling/counterboring, depth of cut (ap) should not exceed 1.2 x DC.

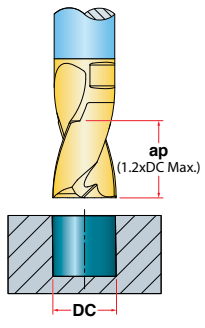

For through bores, reduce feed rate by 50% before exiting workpiece material.

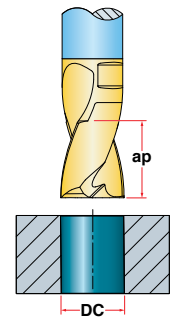

For drilling on inclined surfaces up to 30°, reduce parameters by 30% and on surfaces up to 45° by 50%.

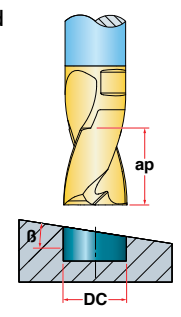

\*Feed / Rev is based on Two-Effective (do not double).

Materials				Vc Cutting Speed SFM	DC Cutting Dia. (inch)	f* Feed/Rev (inch)	Coolant
ISO	Mat'l Group #VDI 3323	Type	Examples				
P	1 - 5	Non-alloy Steel	1018, A36, 1045, A572, 1070	170-450	0.312	.004-.008	No
					0.375	.004-.009	
					0.500	.005-.010	
					0.625	.006-.012	
					0.750	.007-.013	
	6 - 9	Low-alloy Steel	4140, 4340, P20, 8620, 300M	140-350	0.312	.004-.008	
					0.375	.004-.009	
					0.500	.005-.010	
					0.625	.006-.012	
	10 - 11	High-alloy Steel	H13, A2, D2, M2, T1	130-300	0.312	.004-.007	
					0.375	.004-.008	
					0.500	.005-.009	
M	12 - 14	Stainless Steel	410, 416, 440, 303, 304, 316, 15-5, 17-4	100-230	0.312	.004-.006	May be required at high speeds
					0.375	.005-.007	
					0.500	.006-.008	
					0.625	.006-.009	
					0.750	.006-.010	
K	15 - 18	Iron	CLS. 20, 30, 45, 60-40-18, 100-70-03	265-550	0.312	.004-.010	No
					0.375	.004-.011	
					0.500	.005-.012	
					0.625	.005-.013	
					0.750	.006-.014	
S	31 - 37	High-Temp, Ti	Inconel, Hastelloy, 6Al-4V, 5Al-5Mo-5V-3Cr	70-165	0.312	.002-.004	Yes
					0.375	.003-.005	
					0.500	.004-.006	
					0.625	.005-.007	
					0.750	.005-.008	

Note: Feed and speed recommendations are starting operating parameters. They are only guidelines from which further optimization should take place. Operating parameters are influenced by many machining variables. These variables may cause for reductions in feeds and speed or dramatic increases. Additionally, DOC and WOC may need to be revised to optimize the tools performance.

## CHIPSURFER™ OPERATING GUIDELINES: 45Z • CENTER DRILL

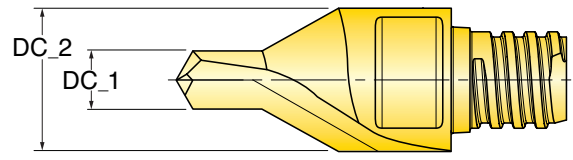

Calculate speed and feed based on DC\_1.

\*Feed / Rev is based on Two-Effective (do not double).

Materials				Vc Cutting Speed SFM	DC Cutting Diameter (inch)	f* Feed/Rev (inch)
ISO	Mat'l Group #VDI 3323	Type	Examples			
P	1 - 5	Non-alloy Steel	1018, A36, 1045, A572, 1070	170-450	0.118-0.185	.002-.006
					0.186-0.292	.003-.007
	6 - 9	Low-alloy Steel	4140, 4340, P20, 8620, 300M	140-350	0.118-0.185	.002-.004
					0.186-0.292	.002-.005
	10 - 11	High-alloy Steel	H13, A2, D2, M2, T1	130-300	0.118-0.185	.002-.004
					0.186-0.292	.002-.005
M	12 - 14	Stainless Steel	410, 416, 440, 303, 304, 316, 15-5, 17-4	100-230	0.118-0.185	.002-.004
					0.186-0.292	.002-.005
K	15 - 18	Iron	CLS. 20, 30, 45, 60-40-18, 100-70-03	265-550	0.118-0.185	.005-.010
					0.186-0.292	.007-.013
N	21 - 30	Non Ferrous & Non Metallic	7075, 6061, Duroplastics	300-725	0.118-0.185	.003-.010
					0.186-0.292	.007-.014
S	31 - 37	High-Temp, Ti	Inconel, Hastelloy, 6Al-4V	70-165	0.118-0.185	.001-.003
					0.186-0.292	.002-.004
H	38-39	Hardened Steel >48	A2, O1, D2	50-125	0.118-0.185	.001-.002
					0.186-0.292	.001-.003

Note: Feed and speed recommendations are starting operating parameters. They are only guidelines from which further optimization should take place. Operating parameters are influenced by many machining variables. These variables may cause for reductions in feeds and speed or dramatic increases. Additionally, DOC and WOC may need to be revised to optimize the tools performance.



**CHIPSURFER™ OPERATING GUIDELINES: 45Z\_RA • SPOT DRILL**

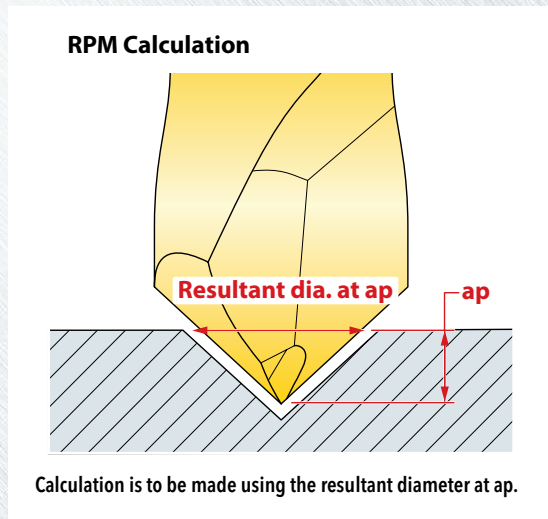

\*Feed / Rev is based on Two-Effective (do not double).

ISO	Material	Brinnell Hardness	Vc Cutting Speed SFM	f* Feed/Rev (inch)	Coolant	
P	Steel	Low Carbon 1018, 8620	150-250	200-500	.003-.008	No
		High Carbon F-6180	250-400			
		Alloyed Steel 4140, 4340	150-300			
M	Stainless Steel	300 Series, 304, 316	-	200-400	.003-.006	May not be needed at high speeds
		400 Series 15-5 PH	Up to 320			
		13-8 PH	-			Yes
K	Cast Iron	Gray	150-250	250-550	.003-.010	No
		Nodular	150-250			
S	Titanium	6AL-4V	-	70-150	.002-.005	Yes

Note: Feed and speed recommendations are starting operating parameters. They are only guidelines from which further optimization should take place. Operating parameters are influenced by many machining variables. These variables may cause for reductions in feeds and speed or dramatic increases. Additionally, DOC and WOC may need to be revised to optimize the tools performance.